



**PATENTED RIVETING MACHINE**  
**YOSHIKAWA IRON WORKS**

Riveting controller  
**YC-301**

External input/output

Operating Instructions



- Be sure to read this manual carefully before using the product and use it correctly. Improper operation may cause unexpected accidents, shorten the life of the product, and degrade its performance.
- Keep this manual in a safe place so that it can be used at any time.



## "Safety Precautions"







The precautions shown here are intended to ensure that you use the product correctly and to prevent injury or damage to you or others. In addition, in order to clarify the degree and importance of the potential danger or damage, there are three levels of classification: "DANGER," "WARNING," and "CAUTION".

Be sure to follow all of these important safety instructions and precautions.

	<b>DANGER</b> Failure to observe these instructions results in an imminent likelihood of death or serious personal injury.
	<b>WARNING</b> Failure to observe these instructions results in the possibility of death or serious personal injury.
	<b>CAUTION</b> Failure to observe these instructions results in the possibility of personal injury or material damage.

## About the symbols

The symbols shown below are used to classify and explain the types of items to be observed. Please read the contents carefully.

	The  symbol indicates a "DANGER," "WARNING," or "CAUTION".
	The  symbol indicates a "prohibited" action that must not be performed.
	The  symbol indicates the contents a "mandatory" action that must be performed.



## DANGER

	<ul style="list-style-type: none"> <li>◆ Be sure to conduct a risk assessment under actual usage conditions of the product after it is delivered, it is moved to a different place, new workers begin to use it, there is a change in products being made, there is a change in the surroundings or layout, etc. Otherwise, fires, electric shocks, death or injury, and equipment damage may result!</li> </ul>
	<ul style="list-style-type: none"> <li>◆ Do not put your hands or fingers under the head of the machine as you may be seriously injured. Be very careful while operating the machine.</li> </ul>
	<ul style="list-style-type: none"> <li>◆ Do not open the control box door. There is a risk of electric shock. If you must open the control box door, first turn off the power and unplug the power cord, before opening the door.</li> </ul>



## WARNING

	<ul style="list-style-type: none"> <li>◆ Secure the machine housing to the floor or to a workbench. If it is not truly secured, the machine may accidentally fall over and injure someone. We cannot guarantee against product damage or personal injury in the event of an accident.</li> </ul>
	<ul style="list-style-type: none"> <li>◆ Do not use any power supply or voltage other than that which is specified. Using a different power supply may cause product failure or start a fire.</li> </ul>
	<ul style="list-style-type: none"> <li>◆ Do not damage the wiring. If a damaged wire causes a short circuit, the cord will melt and may start a fire.</li> </ul>
	<ul style="list-style-type: none"> <li>◆ Do not splash water on the product. Doing so may damage the product or give an electric shock or start a fire.</li> </ul>
	<ul style="list-style-type: none"> <li>◆ Never attempt to disassemble or repair this product unless you are a repair technician. Doing so may start a fire or cause a malfunction resulting in personal injury. In case the machine needs repair or fails to work correctly, please contact our nearest sales office.</li> </ul>
	<ul style="list-style-type: none"> <li>◆ Do not touch the switches with wet hands. Doing so may give you an electric shock or cause a malfunction.</li> </ul>



## CAUTION

	<ul style="list-style-type: none"><li>◆ Turn off the power before replacing the head, the insert, or a jig. Doing so while operating the machine may result in injury due to incorrect operation.</li></ul>
	<ul style="list-style-type: none"><li>◆ After installing or relocating the machine, be sure to remove the head from the machine and check the direction of the motor's rotation when performing a test run. If it rotates in the wrong direction, the head may come off and cause damage or a personal injury.</li></ul>
	<ul style="list-style-type: none"><li>◆ Do not put your fingers or other objects into the rotating parts of the motor during operation. Doing so may cause a personal injury or a machine malfunction.</li></ul>
	<ul style="list-style-type: none"><li>◆ Since the source pressure of the riveter is already set for each model, do not change it without knowing what you are doing. If you use the machine at a pressure above the existing setting, it may damage the machine or cause it to malfunction.</li></ul>
	<ul style="list-style-type: none"><li>◆ Be sure to connect all wires and terminals securely. If you don't, it may result in a poor contact, damage the machine or cause it to malfunction.</li></ul>
	<ul style="list-style-type: none"><li>◆ Please use only genuine items from us, for use as consumables and replacement parts. If you don't, it may damage the machine or cause it to malfunction. When disposing of the machine and/or any parts, treat them as industrial waste.</li></ul>
	<ul style="list-style-type: none"><li>◆ In the event of an accident or machine damage or failure, immediately turn off the power and stop operation. If repair is required, please contact our nearest sales office.</li></ul>
	<ul style="list-style-type: none"><li>◆ If the power is turned off for a long time, the cylinder will drop. If there is any interference (contact) with jigs, or other items nearby, it may damage the machine.</li></ul>
	<ul style="list-style-type: none"><li>◆ Do not allow any mechanical shocks (impacts) when installing the machine. They may cause a machine failure.</li></ul>

## "Disclaimer"

In the unlikely event that a problem occurs with this product, we will deal with it based on the following exclusions and disclaimer.

- Defects caused by not following the precautions described in this instruction manual.
- Defects due to design and installation that violate the descriptions in this operation manual
- Defects due to any use other than the intended purpose described in this operation manual
- Defects caused by the installation and handling of the machine because of user instructions given to the designers and installers that are not part of the standard specifications.
- Modified machine specifications or performance after delivery and any defects caused by that.
- Defects caused by use, storage, transportation, etc., outside of the range of environmental conditions normally expected at the time of development, manufacturing, and sales
- Defects caused by force majeure (natural disasters, landslides, ground subsidence, fires, explosions, riots, etc.)
- If any defect is not reported promptly after being discovered

## "Precautions for safe use"

### 1. Operating conditions and ambient environment

- Please check the operating conditions of the machine and its environment, including the operating hours and machine settings, the resulting finished products, the waste generated during production, the temperature, humidity, altitude, and atmosphere, such as dust or gas in air at the place where the machine is used
- If the customer moves or exports the product overseas, they should check the power supply, installation environment, surrounding environment, etc. of the country or region where it will be used.

### 2. Need to check local requirements at the place of intended use (licensing, municipal regulations, etc.)

- Check the local ordinances where the machine will actually be used.
- If the customer moves or exports the product overseas, they should check the laws, regulations, and ordinances of the country or region where the product will be used.

### 3. Necessity for worker education

- The machine may only be installed by a trained person, such as a professional contractor or a specialized person. In the case of special work stipulated by laws and ordinances, only a qualified person, or a person who has undergone the necessary training, should perform the work.
- Only persons who have had safety training should perform any work using the machine.
- Work using the machine should only be performed by trained personnel.
- Maintenance work must be performed by engineers or technicians with the necessary mechanical and electrical expertise. In the case of special work stipulated by laws and ordinances, only a qualified person, or a person who has undergone the necessary training, should perform the work.

### 4. Necessity of a risk assessment

- Perform a risk assessment under the actual conditions of use, such as the environment, location, and qualifications of workers at the place where the machine will actually be used.

Various safety devices are available as options, so please contact our sales office.



## "Precautions for safe use"

### 5. Need for primary power protection

- If power supply circuit protection is required as the result of the risk assessment, take the appropriate protective measures.
- Various protective devices are available as options, so please contact our sales office.
- If electrical noise countermeasures are required for the machine power supply line, etc., please contact our sales office.

### 6. Need to identify the people involved, including people making repairs

- To use this machine, we recommend that the customer clarify the work details and scope of responsibility as shown below. Please check each item before starting operation.

① Transportation/Installation: Transporter, machine transportation, and installation manager

② Electrical work and wiring: Electrical worker, electric engineer

③ Production: Workers who have had safety training and received explanations of working conditions

④ Setup changes, new model addition: Only performed by workers and managers who have had safety training and received explanations of the working conditions,

⑤ Maintenance and inspection: Mechanical and electrical maintenance engineers

⑥ Repair (mechanical system): Mechanical maintenance engineer (limited to the scope specified in the manual)

⑦ Repair (electrical system): Electrical maintenance engineer (limited to the scope specified in the manual)

⑧ Other repairs: Manufacturer

⑨ Disposal: Disposal contractor, person in charge of the disposal business

\* If ①, ②, ⑤, ⑥, and ⑦ above are special work specified by law, the work should be only be done by a qualified person or a person who has received the necessary training.

### 7. About disposal

- When disposing of the machine, check the requirements of the municipality where it will be disposed.
- When disposing of the product overseas, check the laws, rules and regulations of the country or region where the product will be disposed.

**In the event of a failure or malfunction, please contact our sales office.**

## CONTENTS

1. YC-301 wiring diagram	1
2. External input signals	
2-1. Riveting controller input signals	2
1) Start signal	2
2) External power ON input	2
3) External interlock input	3
4) External automatic mode input	4
5) External spindle input	5
6) External emergency stop input	6
7) Riveting descent-end input	7
8) Riveting mid-point input	8
2-2. Riveting controller output signals	9
1) Power ON output	9
2) Auto mode output	10
3) Spindle rotating (SPINDLE) output	11
4) Riveting completed output	12
5) Error output	13
6) Riveting ascent-end position output	14
7) Riveting descent-end position output	14
8) Count up output	15



# 1. YG301 wiring diagram

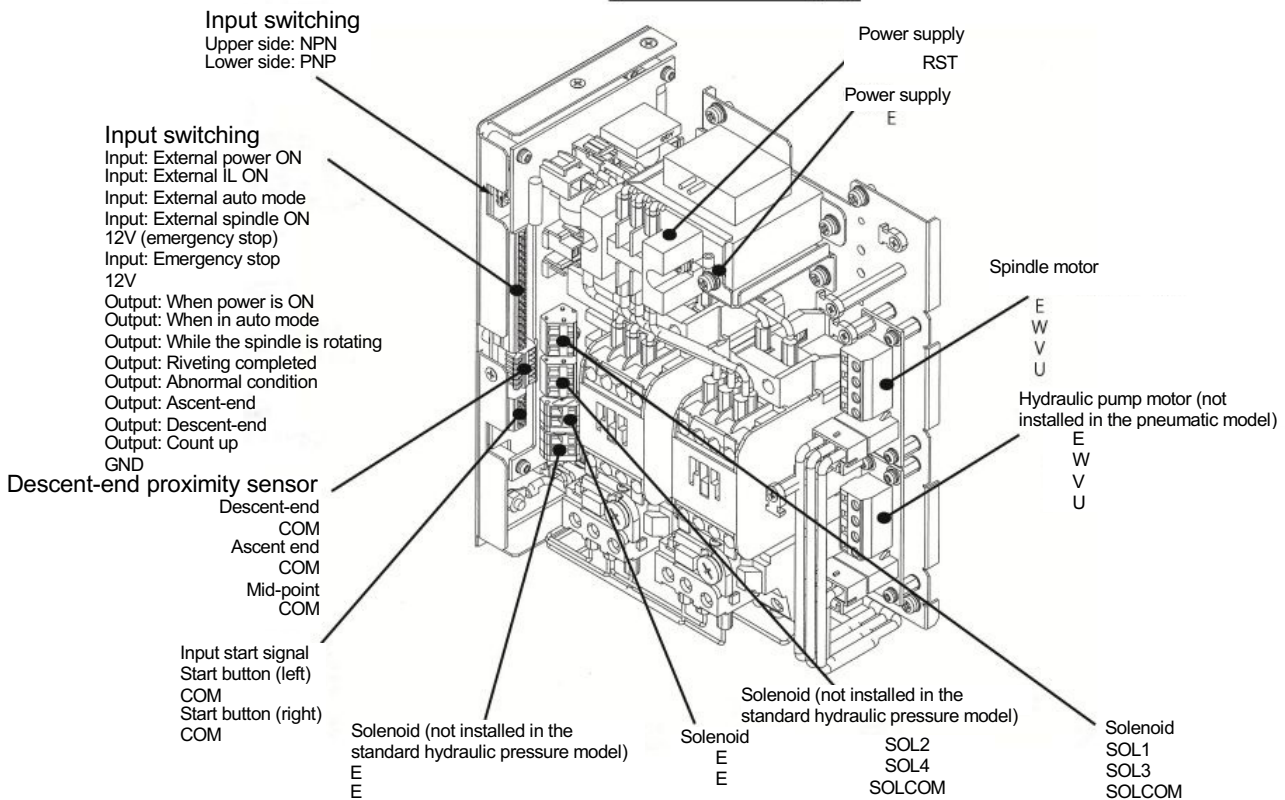
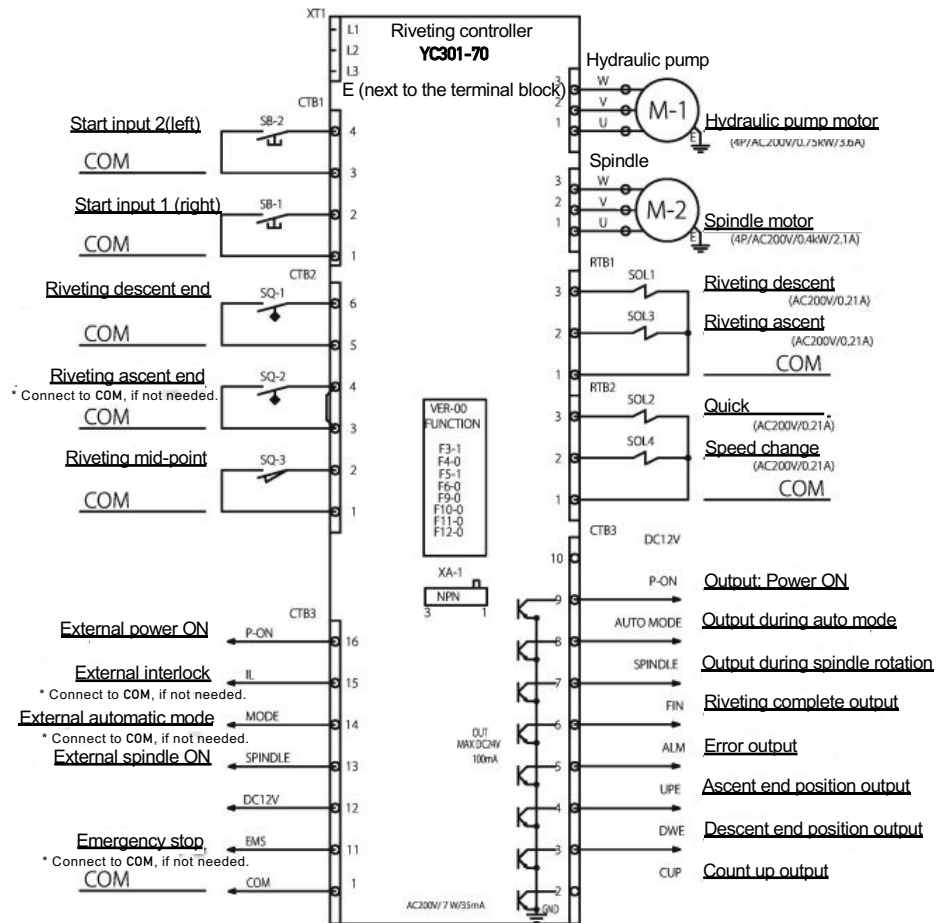



## 2. External I/O signals

### 2-1. Riveting controller input signals

#### 1) Start signal

A start signal can be input from an external relay contact or from a programmable controller.

#### Connection diagram 1

(When used by connecting to a contact, such as a relay)

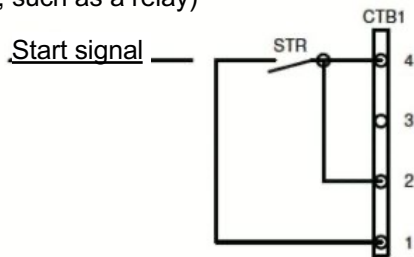

#### Connection diagram 2

(When directly connected to a programmable controller)

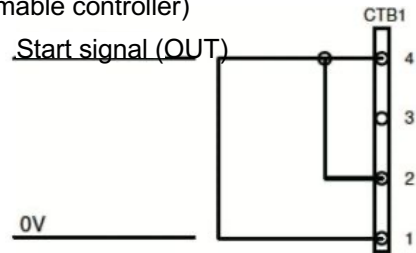

#### 2) External power ON (input)

A start signal can be input from an external relay contact or from a programmable controller.

External power supply ON: When the input signal rises, the controller power is turned on.

External power supply OFF: When the input signal falls, the controller power is turned off.

**⊘ CAUTION**

After turning on the controller's primary power, turn this signal off and then on again. If this signal is on while the primary power is turned on, the controller power will not be turned on.

#### Connection diagram 3

(When used by connecting to a contact, such as a relay)

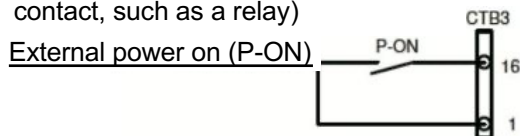

#### Connection diagram 4.

(When directly connected to a programmable controller)

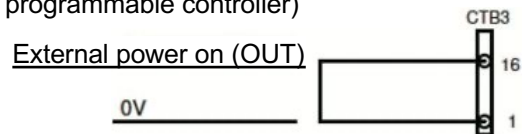

### Signal timing

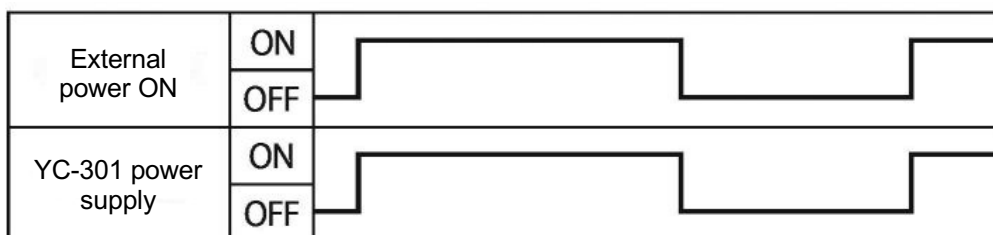



### 3) External interlock input

An interlock signal can be input from an external relay contact or from a programmable controller. When the interlock signal is turned off, [IL] is displayed on the controller display, and the riveter cannot start operation.

Use this signal to enable riveter operation.

**Connection diagram 5.**  
(When used by connecting to a contact, such as a relay)



**Connection diagram 6.**  
(When directly connected to a programmable controller)

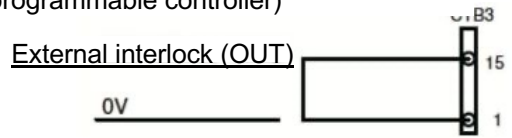

### Signal timing

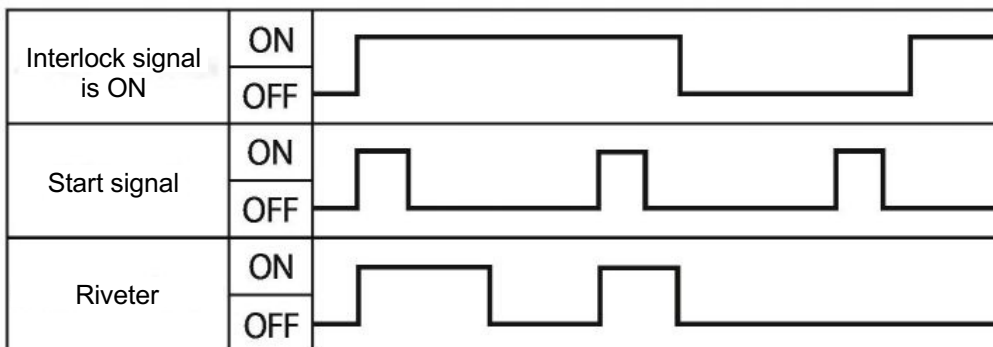

If the interlock signal turns off while the riveter is operating, the riveter will stop the operation.

#### 4) External automatic mode input

The start mode signals can be input from an external relay contact or from a programmable controller.

- The riveter will only work while a start signal is being input while in manual mode (the MODE signal will be off).
- The riveter will only perform one cycle when a start signal is input while in auto mode (the MODE signal will be on).

##### Connection diagram 7.

(When used by connecting to a contact, such as a relay)

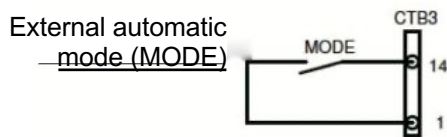

##### Connection diagram 8.

(When directly connected to a programmable controller)

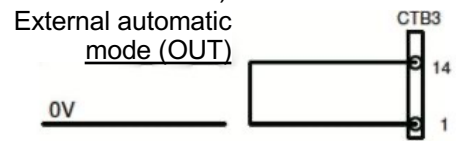

#### Signal timing

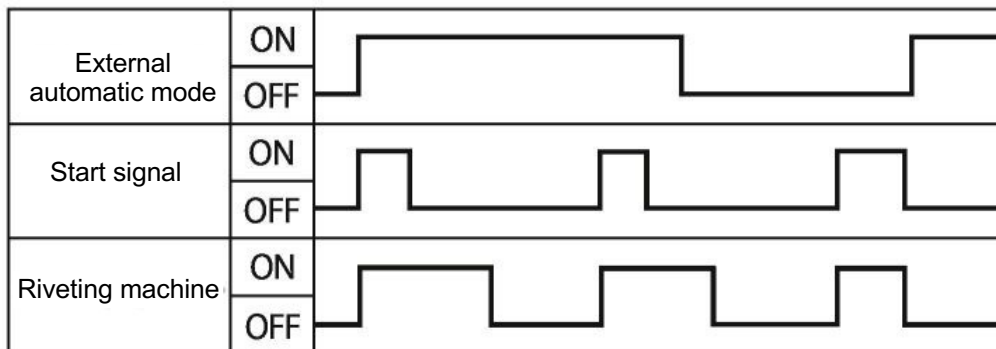



## 5) External spindle input

The spindle rotation can be externally started/stopped by a signal from a relay contact or directly from a programmable controller.

(To enable this signal, Function F04 must be set to "2".)

To rotate the spindle, turn this signal on. The spindle will rotate while this signal is on, and the controller is outputting a "rotate spindle" signal.

### Connection diagram 7.

(When used by connecting to a contact, such as a relay)

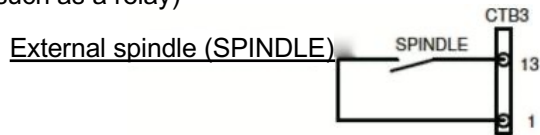

### Connection diagram 8.

(When directly connected to a programmable controller)

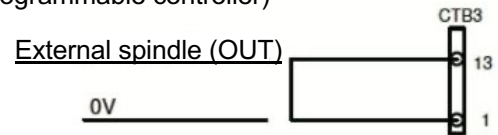

### Signal timing

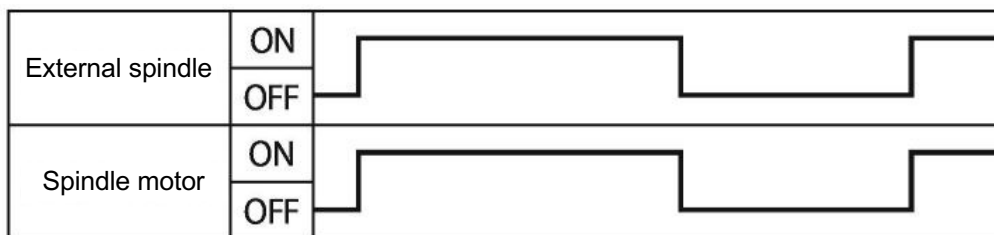

If the spindle signal is switched on or off while the riveter is operating, that change will be reflected after the end of the current operation cycle.

### 6) External emergency stop input

The emergency stop signal can be input from an external relay contact or from a programmable controller. When the power is turned off by an emergency stop, the display will show "E Stop" and the controller power supply will be turned off. After the power is turned off by the emergency stop, the controller has to be turned on again to restart the operation.

#### Connection diagram 9.

(When used by connecting to a contact, such as a relay)

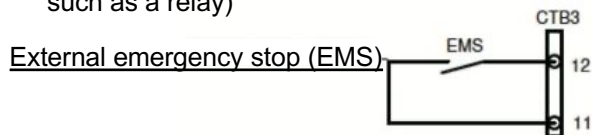

#### Connection diagram 1

(When directly connected to a programmable controller)

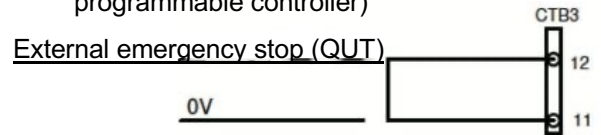

### Signal timing

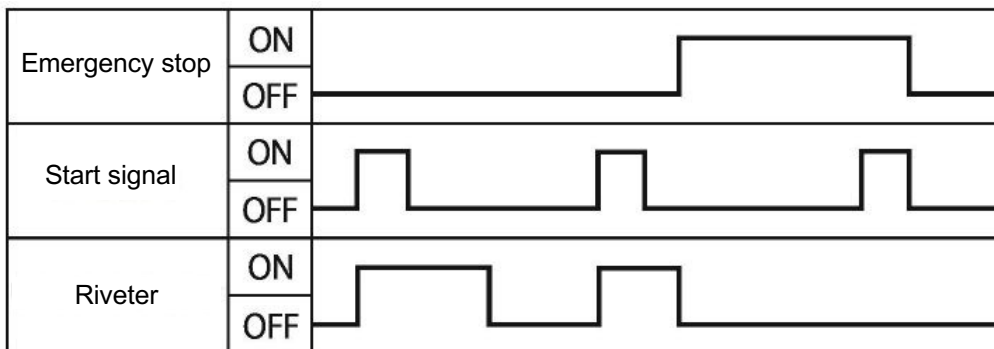



## 7) Riveting descent-end input

By connecting a riveting descent-end sensor, the riveting timer will start to count when the head reaches the descent-end point.

(To enable this timer, function F05 must be set to "1".)

If a descent-end input is not used, the timer will start counting at the same time as the start signal is received.

### Connection diagram 11.

(When used by connecting to a contact, such as a relay)

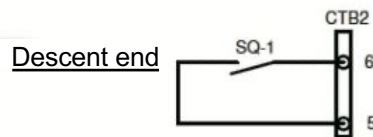

### Signal timing

The riveting timer will start counting when it receives the descent-end signal input from the sensor.

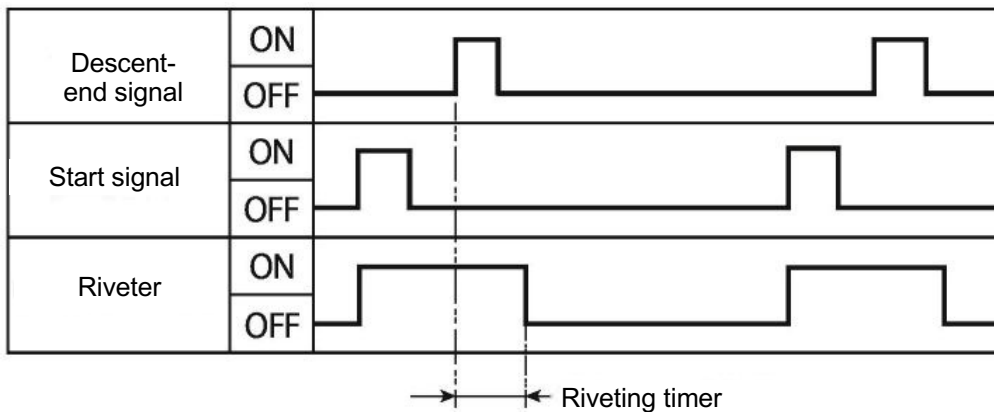

### Signal timing

If there is no descent-end signal, the timer will start counting at the same time as the start operation signal is received.

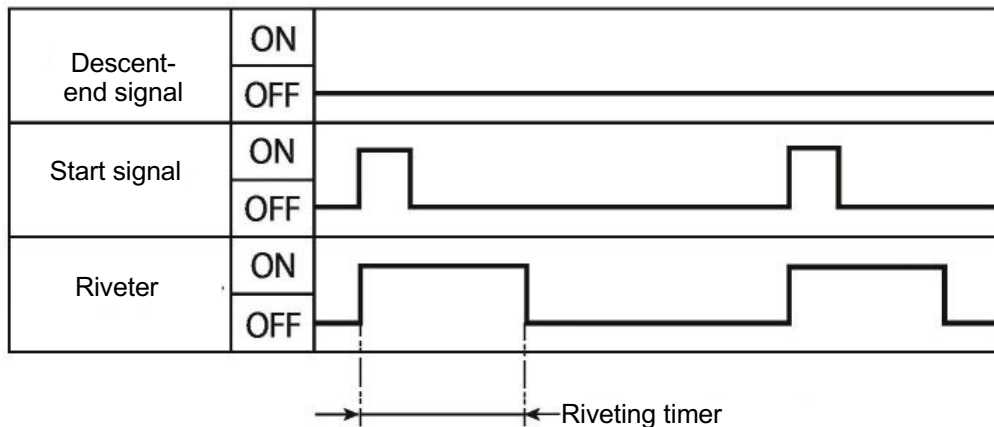

### 8) Riveting mid-point input

When the anti tie-down feature is enabled by connecting a mid-point sensor, the riveter will automatically start counting after the mid-point is reached.

(To enable this timer, function F06 must be set to "2".)

#### Signal timing

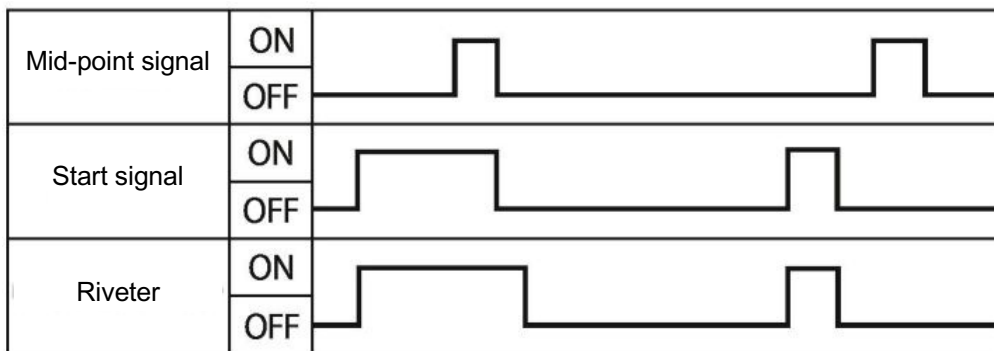

If the start signal is turned off before the head reaches the mid-point, the riveter will stop its operation.

#### Input signal specifications

Contact input (photocoupler isolation)	10 points
Contact current	Max. 6mADC
Maximum off current	0.8mA
Minimum input pulse width	80mS



## 2-2. Riveting controller output signals

### 1) Power ON output

The riveting controller outputs a power on signal.

It is output as long as the YG301 controller power is turned on.

#### Connection diagram 12.

(When using a relay to detect this output)



#### Connection diagram 13.

(When directly connected to a programmable controller)

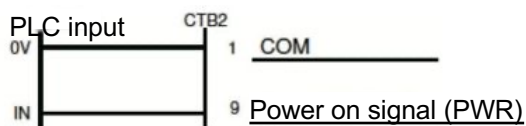

#### Output timing

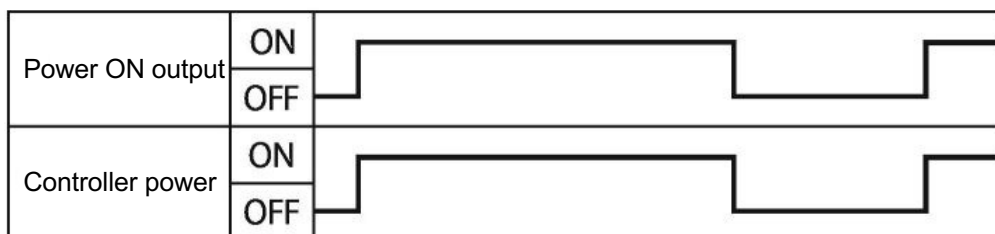



2) Auto mode output

A signal output during automatic mode can be read by the riveting controller. This signal is output when the YG301 controller is in automatic mode.

Connection diagram 14.  
(When using a relay to detect this output)



Connection diagram 15.  
(When directly connected to a programmable controller)

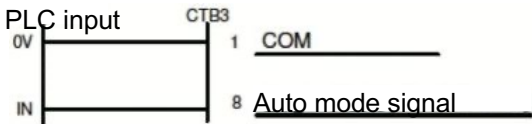

Output timing

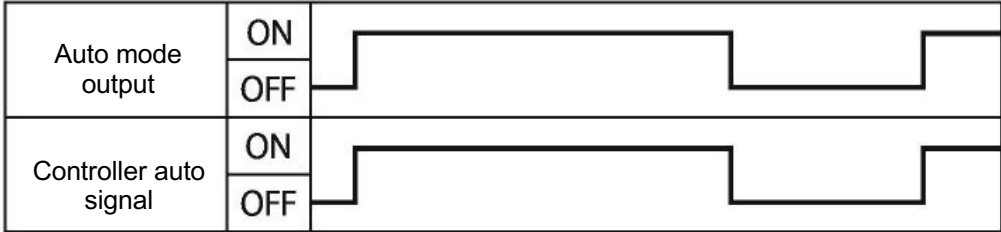



### 3) Spindle rotating (SPINDLE) output 11

Signals can be received from the riveting controller while the spindle is rotating.

It is output when the riveter spindle motor is rotating.

#### Connection diagram 16.

(When using a relay to detect this output)

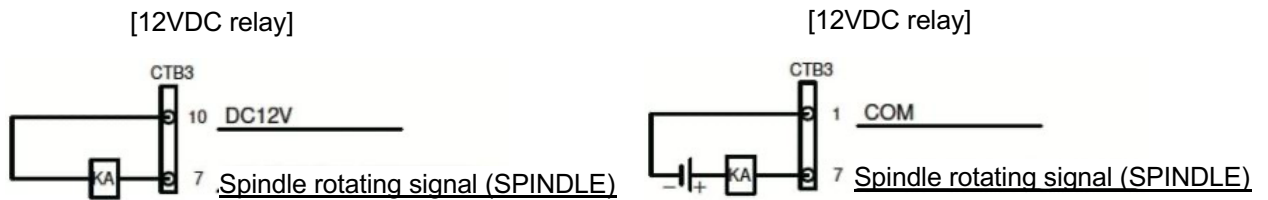

#### Connection diagram 17.

(When directly connected to a programmable controller)

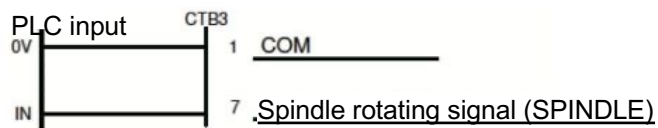

#### Output timing

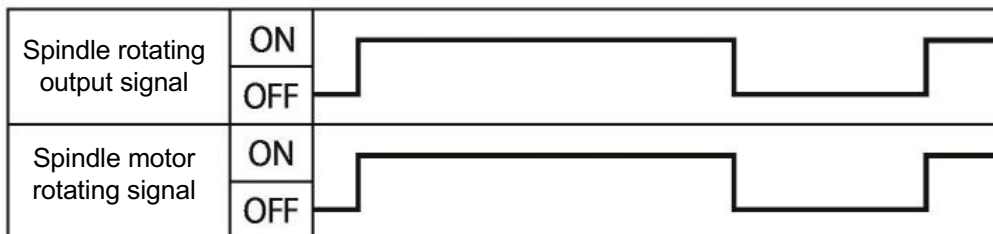

4) Riveting completed output

A riveting completed signal can be output by the riveting controller.  
 The output timing depends on whether or not you are using a riveting head ascent-end sensor signal (This signal is referred to as SQ-2 elsewhere in this manual)

- When SQ-2 is used, the riveting completed signal will only be output after SQ-2 goes on.
- When SQ-2 is not used, the riveting completed signal will be output after the P1 riveting timer has reached the end of its count.

Connection diagram 18.  
 (When using a relay to detect this output)

\* The riveting completed signal is output according to the interval set in parameter NO. P9.

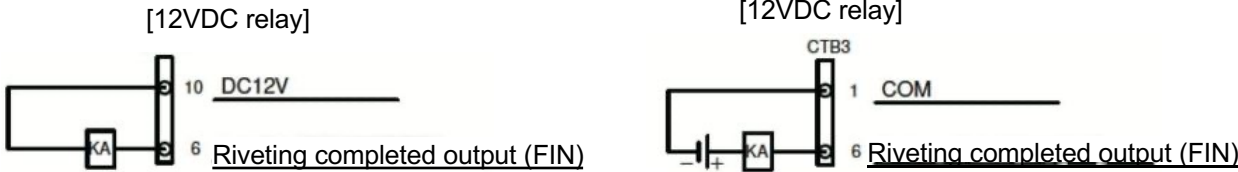

Connection diagram 19.  
 (When directly connected to a programmable controller)

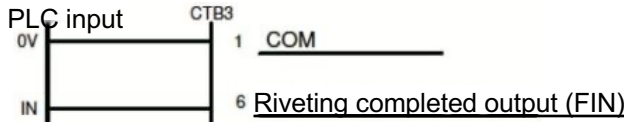

Timing of the riveting completed output signal

When SQ-2 is used

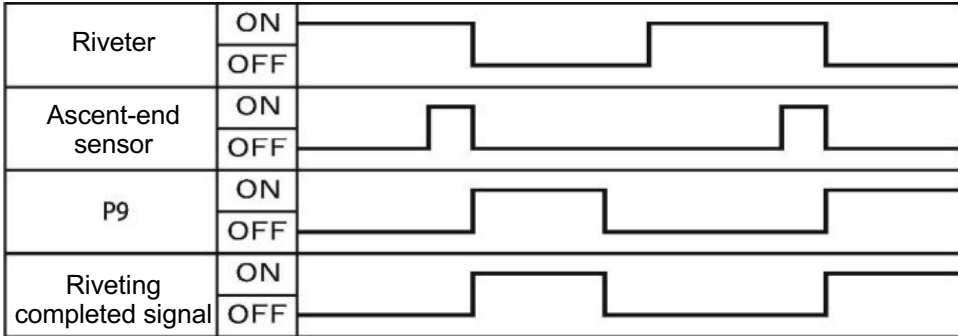

When SQ-2 is not used

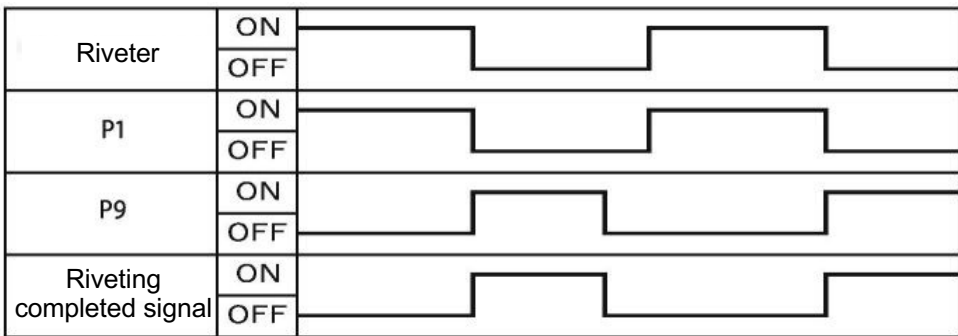

## 5) Error output

Abnormal output signals can be retrieved from the riveting controller.

If an error occurs, press the operation panel reset key to initialize the error data. You cannot turn on the power unless you first initialize the error data.

### Connection diagram 2

(When using a relay to detect this output)

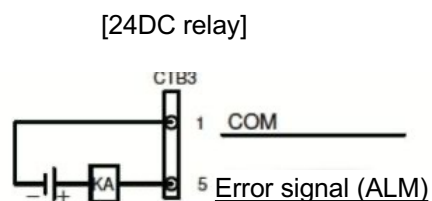
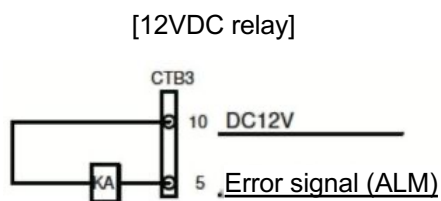

### Connection diagram 21.

(When directly connected to a programmable controller)



### Output timing

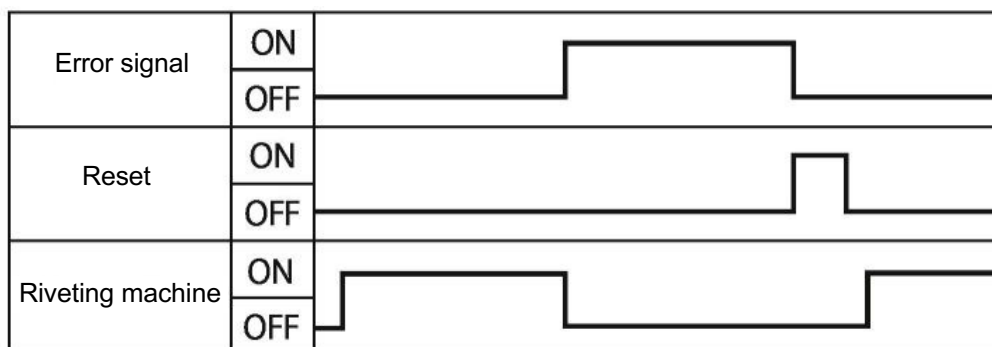

### 6) Riveting ascent-end position output

The riveting head ascent-end signal can be retrieved from the riveting controller.  
SQ-2 input is output without modification.

#### Connection diagram 22.

(When using a relay to detect this output)

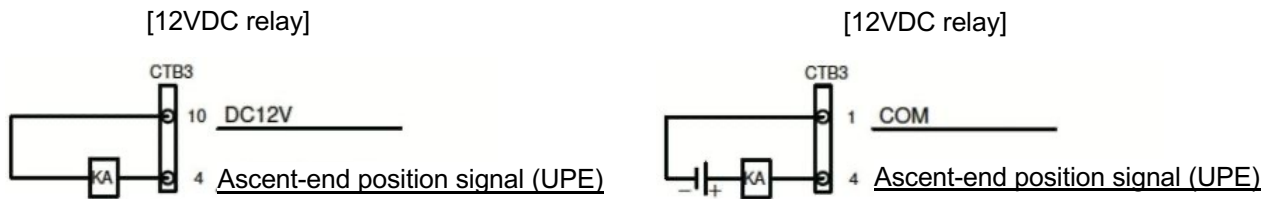

#### Connection diagram 23.

(When directly connected to a programmable controller)

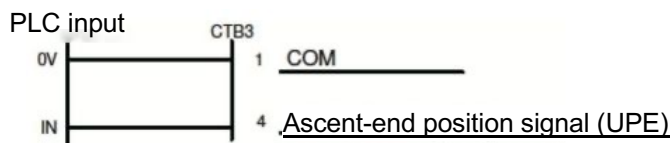

### 7) Riveting descent-end position output

A riveting head descent-end signal can be retrieved from the riveting controller.  
The descent-end SQ-1 input is output without modification.

#### Connection diagram 24.

(When using a relay to detect this output)



#### Connection diagram 25.

(When directly connected to a programmable controller)

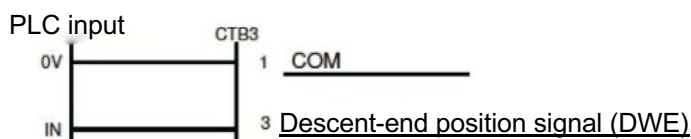



## 8) Count up output

The count up signal can be retrieved from the riveting controller.

(To enable this timer, function F12 must be set to "1".)

During signal output, "C-UP" is displayed on the monitor.

This signal is output after the riveting operation has been repeated for the number of times set in parameter "C". The riveter cannot be started while this signal is being output. By pressing and holding the operation panel reset key, the counter will be reset and the operation can be continued.

### Connection diagram 22.

(When using a relay to detect this output)

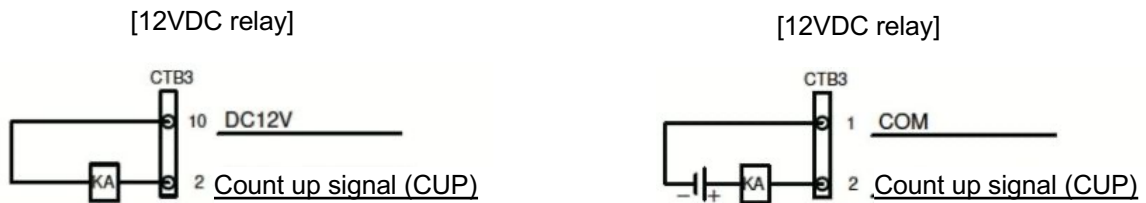

### Connection diagram 23.

(When directly connected to a programmable controller)

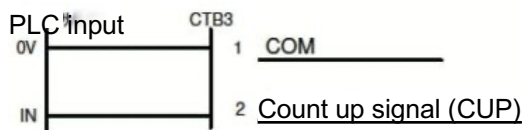

### Output timing

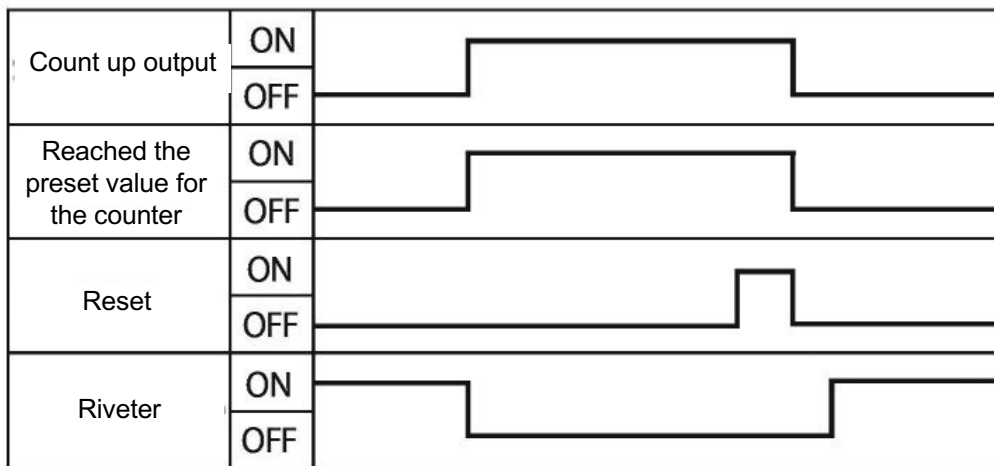

### Output signal specifications

Open collector	8 points
Maximum current rating	100mA
Maximum voltage rating	DC24V

### CAUTION

- If you want to use 24VDC relays, you will have to provide a separate 24VDC power supply. Otherwise, this may cause a machine failure.
- When using the internal 12VDC power, a maximum of 100mA auxiliary power is available. Otherwise, this may cause a machine failure.





## **YOSHIKAWA IRON WORKS CO., LTD.**

Headquarters & Workshop: 3-7, Shitomiya Honmachi, Shijonawate City, Osaka  
TEL: (072)876-5151 FAX: 072-878-3329

Tokyo Sales Office: 4-12, 4 Chome, Okudo, Katsushika Ward, Tokyo  
TEL: (03)3694-1631 FAX: 03-3696-6090

Nagoya Sales Office: 180, 1 Chome, Takenoyama, Nisshin City, Aichi  
TEL: (0561)75-6600~5 FAX: 0561-74-2332