



**PATENTED RIVETING MACHINE**  
**YOSHIKAWA IRON WORKS**

Riveting Controller  
**YC-301**

Operating Instructions



- Be sure to read this manual carefully before using the product and use it correctly. Improper operation may cause accidents, shorten the life of the product, and degrade its performance.
- Keep this manual in a safe place so that it can be used at any time.



## "Safety Precautions"







The precautions shown here are intended to ensure that you use the product correctly and to prevent injury or damage to you or others. In addition, in order to clarify the degree and importance of the potential danger or damage, there are three levels of classification: "DANGER," "WARNING," and "CAUTION".

Be sure to follow all of these important safety instructions and precautions.

	<b>DANGER</b> Failure to observe these instructions results in an imminent likelihood of death or serious personal injury.
	<b>WARNING</b> Failure to observe these instructions results in the possibility of death or serious personal injury.
	<b>CAUTION</b> Failure to observe these instructions results in the possibility of personal injury or material damage.

## About the symbols

The symbols shown below are used to classify and explain the types of items to be observed. Please read the contents carefully.

	The  symbol indicates a "DANGER," "WARNING," or "CAUTION".
	The  symbol indicates a "prohibited" action that must not be performed.
	The  symbol indicates a "mandatory" action that must be performed.



**DANGER**

	<ul style="list-style-type: none"> <li>◆ Be sure to conduct a risk assessment under actual usage conditions of the product after it is delivered, it is moved to a different place, new workers begin to use it, there is a change in products being made, there is a change in the surroundings or layout, etc. Otherwise, fires, electric shocks, death or injury, and equipment damage may result.</li> </ul>
	<ul style="list-style-type: none"> <li>◆ Do not put your hands or fingers under the head of the machine as you may be seriously injured. Be very careful while operating the machine.</li> </ul>
	<ul style="list-style-type: none"> <li>◆ Do not open the control box door. There is a risk of electric shock. If you must open the control box door, first turn off the power and unplug the power cord, before opening the door.</li> </ul>



**WARNING**

	<ul style="list-style-type: none"> <li>◆ Secure the machine housing to the floor or to a workbench. If it is not truly secured, the machine may accidentally fall over and injure someone. We cannot guarantee against product damage or personal injury in the event of an accident.</li> </ul>
	<ul style="list-style-type: none"> <li>◆ Do not use any power supply or voltage other than that which is specified. Using a different power supply may cause product failure or start a fire.</li> </ul>
	<ul style="list-style-type: none"> <li>◆ Do not damage the wiring. If a damaged wire causes a short circuit, the cord will melt and may start a fire.</li> </ul>
	<ul style="list-style-type: none"> <li>◆ Do not splash water on the product. Doing so may damage the product, give someone an electric shock or start a fire.</li> </ul>
	<ul style="list-style-type: none"> <li>◆ Never attempt to disassemble or repair this product unless you are a repair technician. Doing so may start a fire or cause a malfunction resulting in personal injury. In case the machine needs repair or fails to work correctly, please contact our nearest sales office.</li> </ul>
	<ul style="list-style-type: none"> <li>◆ Do not touch the switches with wet hands. Doing so may give you an electric shock or cause a malfunction.</li> </ul>



## CAUTION

	<ul style="list-style-type: none"><li>◆ Turn off the power before replacing the head, the insert, or a jig. Doing so while operating the machine may result in injury due to incorrect operation.</li></ul>
	<ul style="list-style-type: none"><li>◆ After installing or relocating the machine, be sure to remove the head from the machine and check the direction of the motor's rotation when performing a test run. If it rotates in the wrong direction, the head may come off and cause damage or a personal injury.</li></ul>
	<ul style="list-style-type: none"><li>◆ Do not put your fingers or other objects into the rotating parts during operation. Doing so may cause a personal injury or a machine malfunction.</li></ul>
	<ul style="list-style-type: none"><li>◆ Since the source pressure of the riveter is already set for each model, do not change it without knowing what you are doing. If you use the machine at a pressure above the existing setting, it may damage the machine or cause it to malfunction.</li></ul>
	<ul style="list-style-type: none"><li>◆ Be sure to connect all wires and terminals securely. If you don't, it may result in a poor contact, damage the machine or cause it to malfunction.</li></ul>
	<ul style="list-style-type: none"><li>◆ Please use only genuine items purchased from us, for use as consumables and replacement parts. If you don't, it may damage the machine or cause it to malfunction. When disposing of the machine and/or any parts, treat them as industrial waste.</li></ul>
	<ul style="list-style-type: none"><li>◆ In the event of an accident or machine damage or failure, immediately turn off the power and stop operation. If repair is required, please contact our nearest sales office.</li></ul>
	<ul style="list-style-type: none"><li>◆ If the power is turned off for a long time, the cylinder will drop. If there is any interference (contact) with jigs, or other items nearby, it may damage the machine.</li></ul>
	<ul style="list-style-type: none"><li>◆ Do not allow any mechanical shocks (impacts) when installing the machine. They may cause a machine failure.</li></ul>

## "Disclaimer"

In the unlikely event that a problem occurs with this product, we will deal with it based on the following exclusions and disclaimer.

- ◆ Defects caused by not following the precautions described in this instruction manual.
- ◆ Defects due to design and installation that violate the descriptions in this operation manual
- ◆ Defects due to any use other than the intended purpose described in this operation manual
- ◆ Defects caused by the installation and handling of the machine because of user instructions given to the designers and installers that are not part of the standard specifications.
- ◆ Modified machine specifications or performance after delivery and any defects caused by that.
- ◆ Defects caused by use, storage, transportation, etc., outside of the range of environmental conditions normally expected at the time of development, manufacturing, and sales.
- ◆ Defects caused by force majeure (natural disasters, landslides, ground subsidence, fires, explosions, riots, etc.)
- ◆ If any defect is not reported promptly after being discovered.

## "Precautions for safe use"

### 1. Operating conditions and ambient environment

- Please check the operating conditions of the machine and its environment, including the operating hours and machine settings, the resulting finished products, the waste generated during production, the temperature, humidity, altitude, and atmosphere, such as dust or gas in air at the place where the machine is used
- If the customer moves or exports the product overseas, they should check the power supply, installation environment, surrounding environment, etc. of the country or region where it will be used.

### 2. Need to check local requirements at the place of intended use (licensing, municipal regulations, etc.)

- Check the local ordinances where the machine will actually be used.
- If the customer moves or exports the product overseas, they should check the laws, regulations, and ordinances of the country or region where the product will be used.

### 3. Necessity for worker education

- The machine may only be installed by a trained person, such as a professional contractor or a specialized person.

In the case of special work stipulated by laws and ordinances, only a qualified person, or a person who has undergone the necessary training, should perform the work.

- Only persons who have had safety training should perform any work using the machine.
- Work using the machine should only be performed by trained personnel.
- Maintenance work must be performed by engineers or technicians with the necessary mechanical and electrical expertise.

In the case of special work stipulated by laws and ordinances, only a qualified person, or a person who has undergone the necessary training, should perform the work.

### 4. Necessity of a risk assessment

- Perform a risk assessment under the actual conditions of use, such as the environment, location, and qualifications of workers at the place where the machine will actually be used.  
Various safety devices are available as options, so please contact our sales office.



## "Precautions for safe use"

### 5. Need for primary power protection

- If power supply circuit protection is required as the result of the risk assessment, take the appropriate protective measures.
- Various protective devices are available as options, so please contact our sales office.
- If electrical noise countermeasures are required for the machine power supply line, etc., please contact our sales office.

### 6. Need to identify the people involved, including people making repairs

- To use this machine, we recommend that the customer clarify the work details and scope of responsibility as shown below. Please check each item before starting operation.
  - ① Transportation/Installation: Transporter, machine transportation, and installation manager
  - ② Electrical work and wiring: Electrical worker, electric engineer
  - ③ Production: Workers who have had safety training and received explanations of working conditions
  - ④ Setup changes, new model addition: Only performed by workers and managers who have had safety training and received explanations of the working conditions,
  - ⑤ Maintenance and inspection: Mechanical and electrical maintenance engineers
  - ⑥ Repair (mechanical system): Mechanical maintenance engineer (limited to the scope specified in the manual)
  - ⑦ Repair (electrical system): Electrical maintenance engineer (limited to the scope specified in the manual)
  - ⑧ Other repairs: Manufacturer
  - ⑨ Disposal: Disposal contractor, person in charge of the disposal business

\* If ①, ②, ⑤, ⑥, or ⑦ above are special work specified by law, the work should only be done by a qualified person or a person who has received the necessary training.

### 7. About disposal

- When disposing of the machine, check the requirements of the municipality where it will be disposed.
- When disposing of the product overseas, check the laws, rules and regulations of the country or region where the product will be disposed.

**In the event of a failure or malfunction, please contact our sales office.**

## CONTENTS

<u>1. Names of each part on the operation panel</u>	<u>1</u>
<u>2. General operation</u>	<u>2</u>
<u>2-1. Power supply</u>	<u>2</u>
<u>2-2. Switch to turn the “preparation for operation” mode on and off</u>	<u>2</u>
<u>2-3. Machine operation mode selection (AUTO-MAN)</u>	<u>2</u>
<u>2-4. Turn the spindle motor ON/OFF</u>	<u>2</u>
<u>2-5. Auxiliary (AUX) ON/OFF - optional</u>	<u>2</u>
<u>2-6. Emergency stop</u>	<u>2</u>
<u>3. Display</u>	<u>3</u>
<u>3-1. Counter setting</u>	<u>3</u>
<u>3-2. Parameter settings</u>	<u>4</u>
<u>3-3. Position detection function</u>	<u>5</u>
<u>3-4. Error display</u>	<u>6</u>
<u>4. Function setting</u>	<u>7</u>
<u>4-1. Access and set the functions</u>	<u>8</u>
<u>4-2. Key lock</u>	<u>9</u>
<u>4-3. Initialize the memory</u>	<u>9</u>
<u>5. Hydraulic machine layout diagram</u>	<u>10</u>
<u>6. Hydraulic equipment electrical circuit diagram</u>	<u>11</u>
<u>7. Pneumatic equipment layout diagram</u>	<u>12</u>
<u>8. Pneumatic electrical circuit diagram</u>	<u>13</u>
<u>9. External signals</u>	<u>14</u>



# 1. Names of each part on the operation panel

Front side

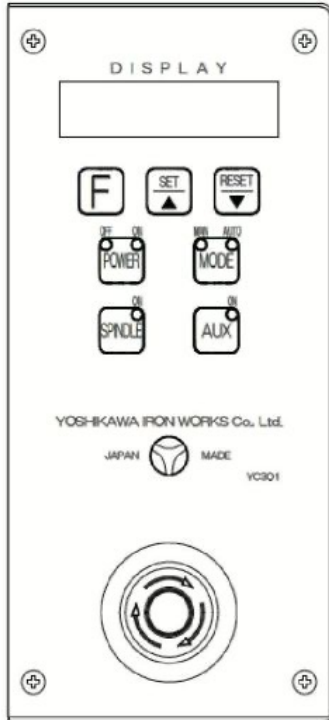

Display

Displays the operation cycle counter and each setting.

Function keys

Use the F key together with other keys to select the operation.

Set or UP key

Can select a function or increment the data.

Reset or DOWN key

Reset the function and the counter or decrement the data.

Power switch

Switches between preparing for operation and turning the power on or off, displays the power status.

Operation mode changeover switch

Change between auto and single operation

Spindle motor on and off switch

Change the spindle motion between rotating and stopped

Auxiliary switch

Single action switch when auxiliary equipment is installed (not used)

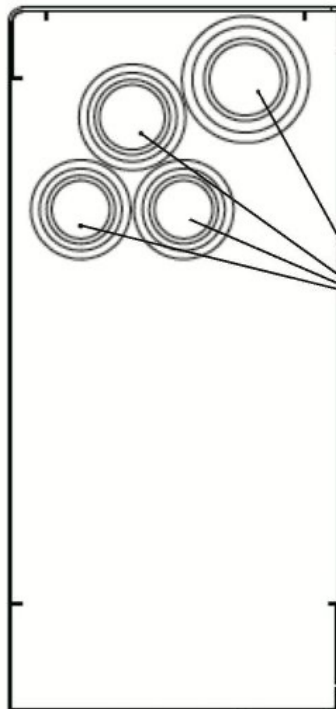

Cable inlet holes

## CAUTION

- Since the operation panel is a thin plastic sheet, do not use a sharp or pointed object to press the keys. Doing so may cut or tear the sheet.



## 2. General operation

### 2-1. Power supply

When the primary power is turned on, the  key red indicator will light.

When turning on the power, if there is an input error or CPU error, a warning message or an error number will be displayed. See "3-4 Error display" for details

### 2-2. Switch to turn the "preparation for operation" mode on and off

Switch the power on and off from the operation panel

Press the  key and the green indicator will light (the hydraulic pump motor will rotate \*1), and the preparation for operation mode will turn on. Press it again to turn it off.

### Operation from an external input (optional)

When the external power supply input is ON (and the circuit between the input ON signal and GND is connected), the preparation for operation mode will be ON. When they are disconnected, the preparation for operation mode will be turned OFF.

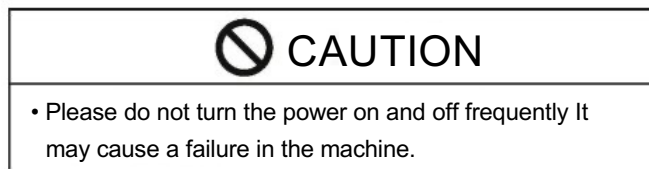



### 2-3. Machine operation mode selection (AUTO-MAN)

Each time you press the  key, the operation mode will change between automatic and single cycle. It can also be changed by connecting the external mode signal to ground (MODE-GND).

However, during an operation mode changeover while riveting, MAN will take precedence, and the machine will change from AUTO to MAN. Please note that the machine will not switch from MAN back to AUTO until the riveting operation is finished.

### 2-4. Turn the spindle motor ON/OFF

Each time you press the  key, you are alternating between rotating the spindle motor and stopping it.

While the spindle motor synchronization function (F04) is set to "0", the spindle motor will rotate and stop in conjunction with the ON/OFF state of the  key . While the spindle motor synchronization function (F04) is set to "1", the spindle motor will not rotate immediately, even if the  key is switched ON (green LED is lit). The spindle motor will rotate when the riveting operation starts. While the spindle motor synchronization function (F04) is set to "2", the spindle motor will rotate when the external spindle signal is connected to ground (SPINDLE-GND).

### 2-5. Auxiliary (AUX) ON/OFF - optional

This function is not used on this machine.

### 2-6. Emergency stop

Pressing the emergency stop switch shuts off power to the hydraulic pump and the spindle motor.

The display will show . Pull out the emergency stop button to release the emergency stop.

\*1: The hydraulic pump motor only rotates in hydraulic model machines.



### 3. Display

Normally, the display  shows the number of items produced, and a position detection signal or an error number if an error occurred. After switching to the parameter setting mode, it will show the value of the parameter setting and the function selected.

#### 3-1. Counter setting

##### 1) Production counter, 6 digits (0-999999)

When the riveting cycle (timer from start to riveting finished)\*<sup>2</sup> completes normally, it increments the riveting work count by 1. If it reaches 999999, the counter display will return to 0 the next time it is incremented. Since the count value is stored in memory, it will not disappear even after the power is turned off.

**Note:** If you switch off the start signal before the work timer (P1) times out in the MAN mode, the counter will not increment.

##### 2) Switch the counter on and off, and reset it

When the display is showing the counter, if you press the  key once, the counter function will switch off and  will be displayed.



Pressing the  key enables the counter function and displays the current counter value. While the counter function is OFF, the production counter will not be incremented.



- The counter on/off status is stored even after the power is turned off.

##### Counter reset

To reset the counter, hold down the  key (approximately 2 seconds), the counter will be set to "0".

##### 3) Manually increasing/decreasing the counter number

By pressing the  key plus the  key while the counter is displayed, the counter value will be incremented by one.

By pressing the  key plus  key while the counter is displayed, the counter value will be decremented by one.

Pressing and holding down either of the  or  keys together with  key as above will accelerate the speed of increase or decrease in the number.

\*2: Riveting timer: Descent end hold time

## 3-2. Parameter settings

While the power is on, hold down the **[E]** key for 3 seconds. The display will show **P. 1-2.00** and enter the parameter setting mode.

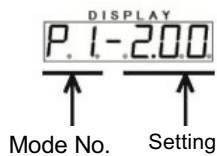

The the code for the mode is displayed to the left of the “-” (in the center). The current setting is displayed to the right of the “-”.

Please check the table below for each mode.

Mode No.	Mode detail	Specification	Available setting range
P1	Riveting operation timer	Riveting timer (Descent end hold time)	0.00 to 9.99 seconds
P3		When program Ver. 004 is selected <sup>*3</sup>	0.00 to 9.99 seconds
P2	Quick (fast forward) timer <sup>*4</sup>	Standard	0.00 to 9.99 seconds
P4		When program Ver. 004 is selected <sup>*3</sup>	0.00 to 9.99 seconds
P8		When program Ver. 003 is selected <sup>*3</sup>	0.00 to 9.99 seconds
P9	Completion signal timer	Output an external signal when the preset riveting completion signal maintenance time has elapsed	0.00 to 9.99 seconds
P0	Intermittent timer, for aging	Set by the machine manufacture. Do not change	0.00 to 9.99 seconds
t	Set the aging number	Set by the machine manufacture. Do not change	0 to 9999 times
Po	Setting the auto power off function	Time to auto power off when not operating (in minutes)	0 to 999 minutes
C	Count up	Output an external signal when the count up reaches the preset number	0 to 9999 times

<sup>\*3</sup>: Program Ver. is set by the manufacturer.

<sup>\*4</sup>: Functions with the optional 2 speed mode.



### 1) Call up mode numbers

While **P. 1-2.00** is displayed, press the **[F]**+**[SET]** key to increase the mode number. Press the **[F]**+**[RESET]** key to decrease the mode number.

Some mode numbers may not be displayed, depending on the controller settings.

### 2) Change current setting

While **P. 1-2.00** is displayed, press the **[SET]** key to increment the first digit by one. Press the **[RESET]** key to decrement that digit by one. Keep holding down the **[F]** key and the **[SET]** or **[RESET]** key to increase/decrease the counter value at high speed.

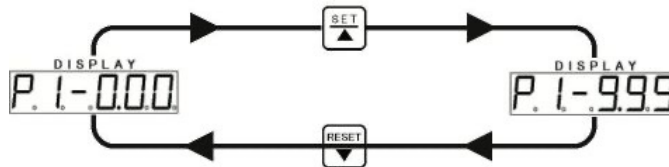

### 3) Confirm that the new number is the setting you want

Hold down the **[F]** key for 3 seconds. The setting mode will end, the display will return to the counter display, and the set value will be stored.

If there is no key operation for 20 seconds on the parameter setting screen, the setting operation will automatically end and the setting displayed on the screen will be stored.

**Note:** Riveting operations can be performed while the parameter settings are displayed, but the counter value will not be increased during that time..

## 3-3. Position detection function

### 1) Riveting ascent end, descent end, and mid-point input monitor

When the sensor detects each of the points during a riveting cycle (ascent end, descent end, and mid-point), the respective decimal points on the counter will light, and you can confirm the input from the sensors at each point.

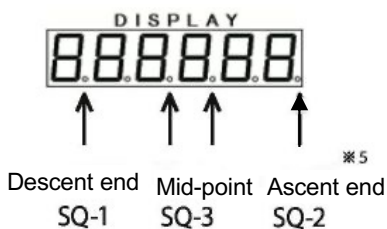

\*5: In the case of a machine without an ascent end sensor (SQ-2), the corresponding point on the monitor display will always be lit because the input signal will be connected to ground.

## 3-4. Error display

An error code or error message will be displayed when an internal controller error, external emergency stop, or a machine error occurs (stored in error memory) is displayed only when the primary side power supply is turned on.

### ◆ Error display list

Display	Details (error status)	Response
<i>Err-01</i>	Memory data error	Press the  key to initialize the data* <sup>6</sup>
<i>Err-10</i>	Abnormal counter value	
<i>Err-11</i>	Abnormal timer P1 data	
<i>Err-12</i>	Abnormal timer P2 data	
<i>Err-13</i>	Abnormal timer P3 data	
<i>Err-14</i>	Abnormal timer P4 data	
<i>Err-15</i>	Abnormal timer P5 data	
<i>Err-16</i>	Abnormal timer P6 data	
<i>Err-17</i>	Abnormal timer P7 data	
<i>Err-18</i>	Abnormal timer P8 data	
<i>Err-19</i>	Abnormal timer P9 data	
<i>Err-20</i>	Abnormal version data	
<i>Err-21</i>	Abnormal function data	
<i>OL-1</i>	Hydraulic pump motor overload	Find and correct the cause of the overload and press the thermal reset button for the pump. (Refer to the equipment layout diagram) If this error occurs frequently, an equipment failure is suspected.
<i>OL-2</i>	Spindle motor overload	Find and correct the cause of the overload and press the thermal reset button for the spindle motor. (Refer to the equipment layout diagram) If this occurs frequently, an equipment failure or motor failure is suspected.
<i>E 5toP</i>	Emergency stop	Reset the external emergency stop button
<i>5b-1</i>	Start input signal 1 by connecting it to GND	Disconnect the signal line from GND and it will be released
<i>5b-2</i>	Start input signal 2 by connecting it to GND	Disconnect the signal line from GND and it will be released

\*6: If an Err-01 data error occurs, the date is automatically initialized and you do not need to do anything.

If an error occurs, press the  key to initialize the error data and the display will turn off. You cannot turn on the power unless you initialize the data.

If the error is still displayed after initialization, please contact our nearest sales office.

## 4. Function setting

You can select the following functions to change their settings.

F No.	Function	Description
F03	Select the memorize key operation	Memorization state of the MODE and SPINDLE keys 0: Not memorized 1: Memorized
F04	Set the Spindle motor for synchronous rotation	Select the spindle motor rotation method 0: From the operation panel switch 1: Synchronous rotation (synchronized with the descent motion) 2: Rotate according to an external command signal
F05	Setting the descent end timer	Select the measurement start position for the riveting timer 0: Start measuring from the start to the descent end 1: Start measuring when the descent end sensor goes on
F06	Anti-tie down setting.	This function keeps the riveter from continuing an auto operation unless you keep pressing the start button until the SQ-1 (descent end) or SQ-3 (mid-point) indicator goes on. 0: Disabled 1: (SQ-1) Enabled 2: (SQ-3) Enabled
F09	Setting the double solenoid	Select whether to enable/disable the ascent valve 0: Disabled 1: Enabled
F10	Setting the auto power off function	This function turns off the power if the operation stops and nothing changes for a specified interval <ul style="list-style-type: none"> <li>• Timer timed out without any operation</li> <li>• Monitors the operations on the operation panel, presses of the start button, or changes in the external control input, and resets the timer.</li> </ul> 0: Disabled 1: Enabled To set the interval-to-power-off time, see "3-2. Parameter settings" on page 4
F11	Setting the start button timing	This function starts auto operation by confirming that the start button is off (for safety). In the Manual mode, the riveter will operate while turned on, the same as before. It is disabled if the anti-tie down function is enabled 0: Disabled (cycle starts when the start button is switched on, as usual) 1: Enabled (switch on the start button in the auto mode, then switch it off to start the cycle operation) Enable or disable the count-up output function
F12	Count-up output setting	No count-up output when disabled 0: Disabled 1: Enabled
F00	Aging setting	Do not change manufacturer's settings <sup>*7</sup>
F99	Turn on descent	For adjusting cylinder descent conditions Set this function to [1] and turn off the power. The cylinder will stay in its descended position after turning on the riveter power and pressing the start button, until the next power off.

\*7: Settings made by the machine manufacturer

## 4-1. Access and set the functions

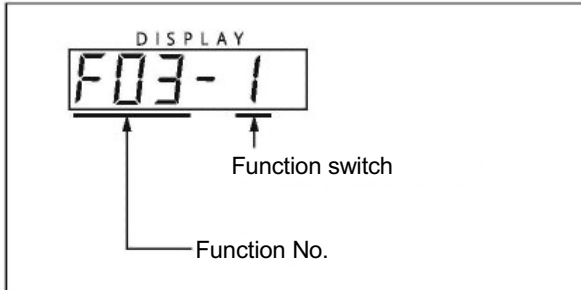

### 1) Access F03 and F04

With the power off, hold down the **F** key and press the **POWER** key. You will see the display shown on the left.

### 2) Access F05 to F12, F99 and F00

While in the power off status, hold down the **F** key, press the **RESET** key and turn the power on by pressing the **POWER** key. You will see the display shown on the left.

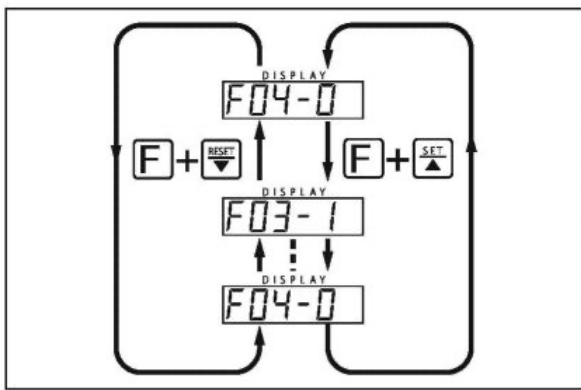

### 3) Selecting a function number

Each time you press the **F** key and the **SET** or **RESET** key, the function selected number will increase or decrease.

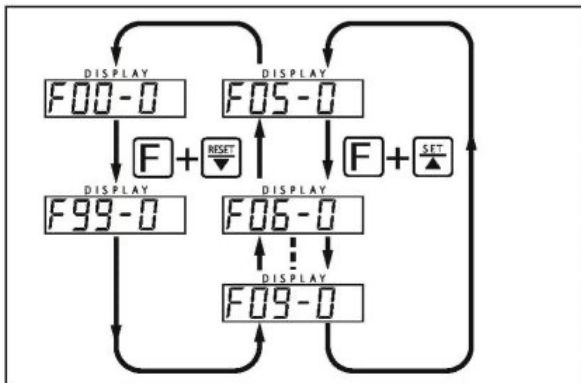

### 4) Switch to enable or disable the selected function

Press the **SET** key. A "1" will be displayed, indicating that the selected function will be enabled. When the **RESET** key is pressed, "0" will be displayed and the selected function will be disabled.

\* Some functions can be set to 0, 1 or 2.

For details, refer to the function list on the previous page.

### 5) Finalize the selected function

After changing the setting in step 4) above, the new settings will be finalized when you turn the power off. The new setting will become effective the next time the power is turned on.

## CAUTION

In order to change the functions, there must not be any errors shown in the controller when you start the machine. Then the power can be turned on. If you turn the controller power on and off using an external signal, arrange it so that just the controller can be powered on separately, by itself. Refer to the electrical circuit diagram. This is needed so that you can set the functions.

\*P-ON, IL, and EMS signals must be connected to ground.



## 4-2. Key lock



Keys other than the  key can be locked to prevent erroneous operations or incorrect settings from the control panel.

### 1) Key lock status display

While the  key green indicator is lit, if the red indicator is flashing it shows that the keys are locked.

When the key lock is released, both indicators will be steadily lit.



### 2) Setting/releasing the key lock

**Locking the keys:** When the keys are not locked and the POWER is OFF, press and hold the  and  keys for 5 seconds. When the green "ON" LED indicator flashes, the keys will become locked.

**Releasing the key lock:** With the keys locked and the POWER ON, press and hold the  key for 5 seconds. The red "OFF" LED will light steadily, and the key lock will be released.

**Note:** It is only approximately 5 seconds. To confirm the actual key lock condition, check whether the indicators are lit or flashing.

## 4-3. Initialize the memory

With the POWER ON, press and hold the  +  +  keys at the same time for 3 seconds. All the data in memory will return to its initial values. However, the function settings will retain the last value set for them.

The initial (default) values for each item in memory are shown below.

Memory item	Initial value	
Counter value	0	
Counter ON/OFF	ON	
Key lock ON/OFF	OFF	
MODE (AUTO/MAN)	MAN	
SPINDLE (ON/OFF)	OFF	
Mode No.	P0	5.00
	P1	2.00
	P2	0.20
	P3	0.00
	P4	0.00
	P5	0.00
	P6	0.00
	P7	0.00
	P8	0.00
	P9	1.00
	Po	60
	C	5000
	t	3000

P3 and P4: In case of program Ver. 04  
P8: In case of program Ver. 3

Function item	Initial value	
Function No.	03	1
	04	0
	05	0
	06	0
	09	0
	10	0
	11	0
	12	0
	99	0
	00	0

 CAUTION

If the keys are locked, the data cannot be initialized.



## 5. Hydraulic machine layout diagram

Hydraulic equipment controller

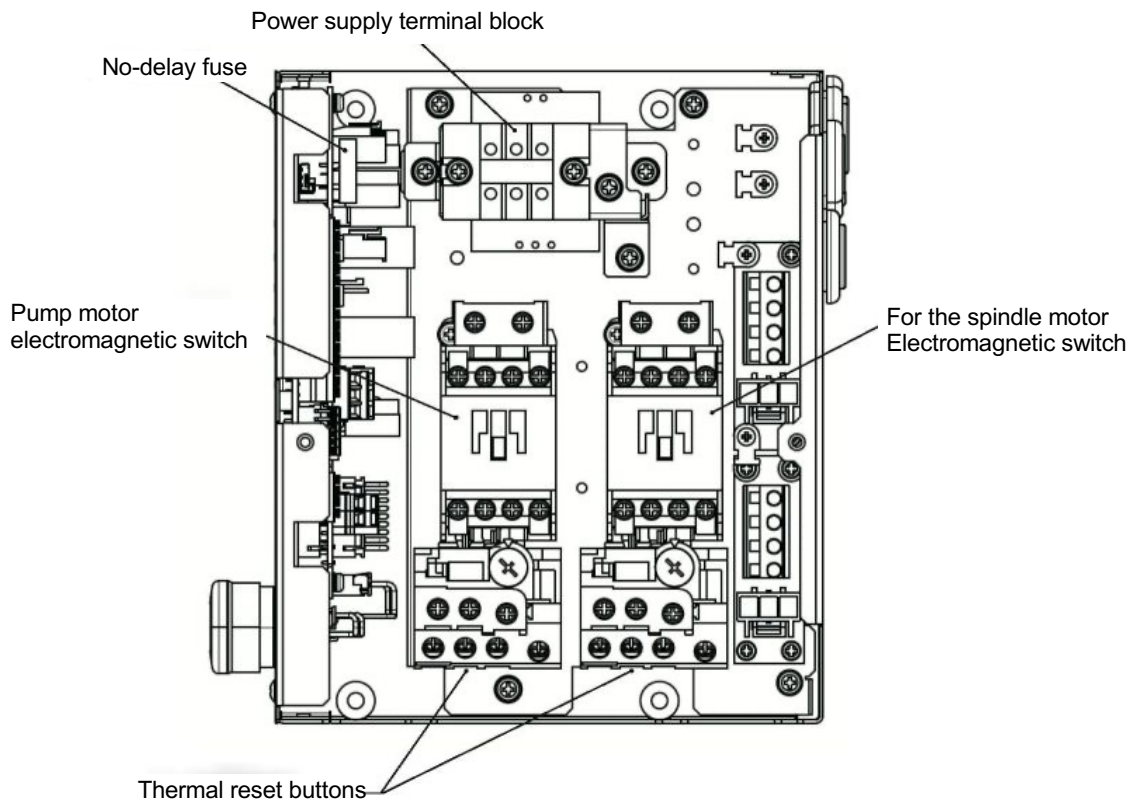

Machine specifications

Model	Power-supply voltage	Power consumption
US-36	3 $\phi$ , 200VAC 50-60HZ	4A/1.4kVA
US-70		6A/2.1kVA
US-150		15A/5.2kVA

Controller specifications

Power supply	200VAC specification
Permitted voltage fluctuation range	$\pm 10\%$
Fuse	3A no-delay glass tube fuse
Ambient temperature	-10~50°C, non-condensing
Auxiliary power supply	+12V and GND 12VDC, 100mA

Controller input/output

Input	Contact input	Photocoupler isolation, 10 each Leak current: 0.8mA or less Minimum input pulse width: 80ms
	Output	For solenoids
		SSR, 2 each Rated load voltage: 100 to 240VAC Minimum current rating: 2A (at minimum 0.1A)
	Power ON	Open collector
	Auto mode	Maximum current rating: 100mA
	Spindle rotation	Maximum voltage rating: 24VDC
	Riveting completed	
	Error	
	Ascent end position	
	Descent end position	
	Count up	

Products recommended for external connection

CTB1.2.3: Rod terminal made by Phoenix Contacts AI0.5-8WH

RTB1.2: Rod terminal made by Phoenix Contacts AI1.5-8BK



## 6. Hydraulic equipment electrical circuit diagram

### Hydraulic equipment controller

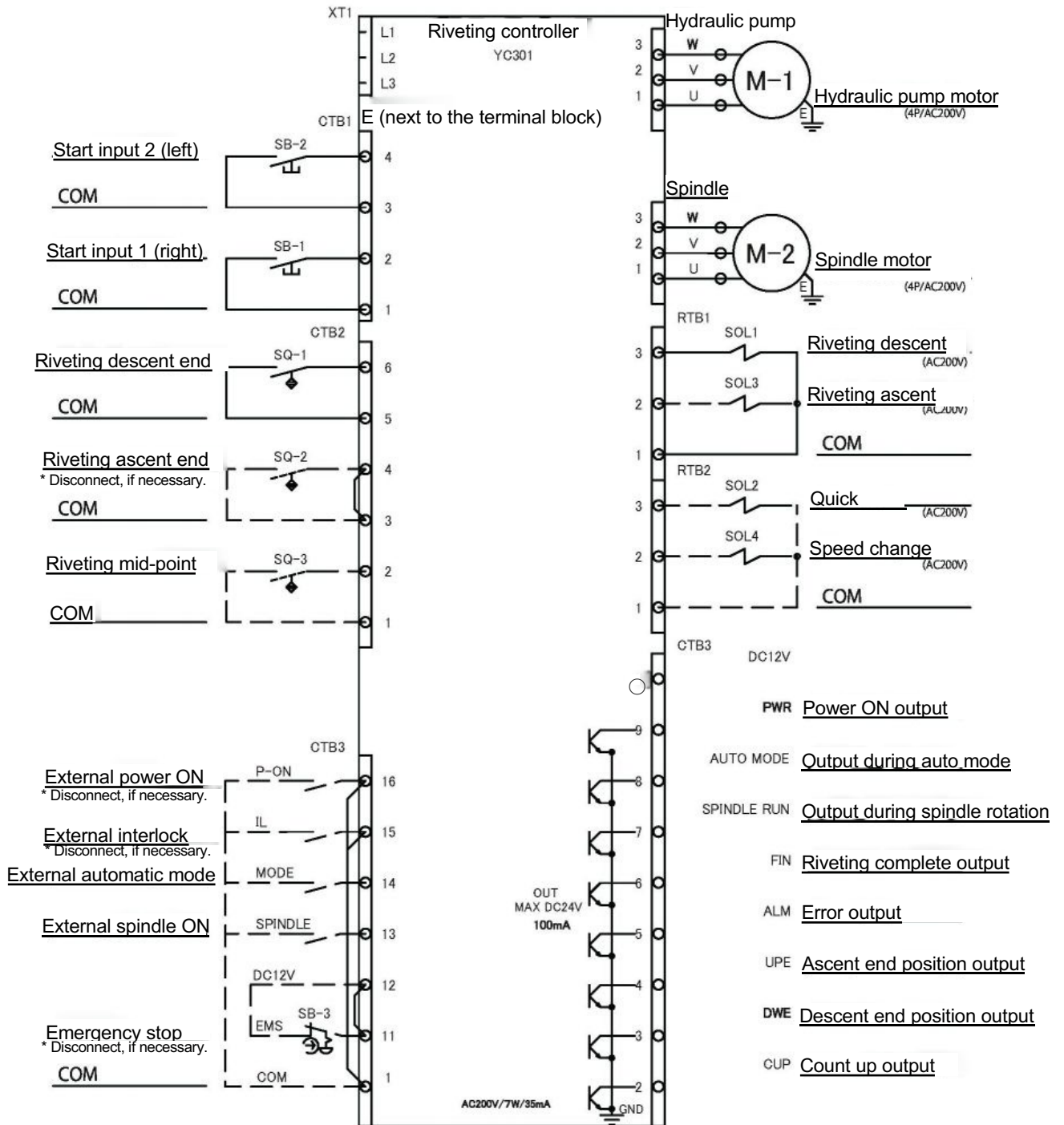

## 7. Pneumatic equipment layout diagram

### Pneumatic controller

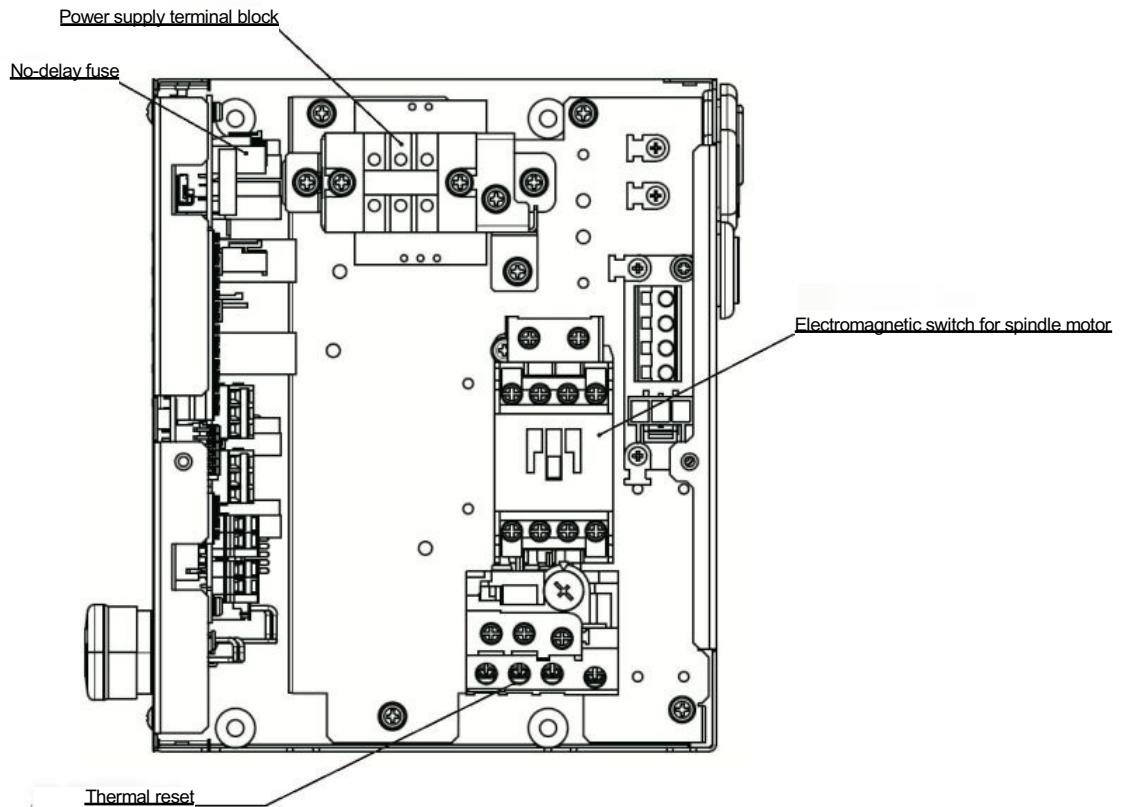

#### Machine specifications

Model	Power-supply voltage	Power consumption
US-66	3ø200VAC 50/60Hz	4A/1.4kVA

#### Controller specifications

Power supply	200VAC specification
Permitted voltage fluctuation range	±10%
Fuse	3A no-delay glass tube fuse
Ambient temperature	-10 to 50° C, non-condensing
Auxiliary power supply	+12V and GND: 12VDC, 100mA

Products recommended for external connection

CTB1.2.3: Rod terminal made by Phoenix Contacts AI0.5-8WH

RTB1.2: Rod terminal made by Phoenix Contacts AI1.5-8BK

#### Controller input/output

Input	Contact input	Photocoupler isolation, 10 each Leak current: 0.8mA or less Minimum input pulse width: 80ms
Output	For solenoids	SSR, 2 each Rated load voltage: 100 to 240VAC Minimum current rating: 2A (at minimum 0.1A)
	Power ON Auto mode Spindle rotation Riveting completed Error Ascent end position Descent end position Count up	Open collector Max. current rating: 100mA Maximum voltage rating: 24VDC



## 8. Pneumatic electrical circuit diagram

### Pneumatic controller

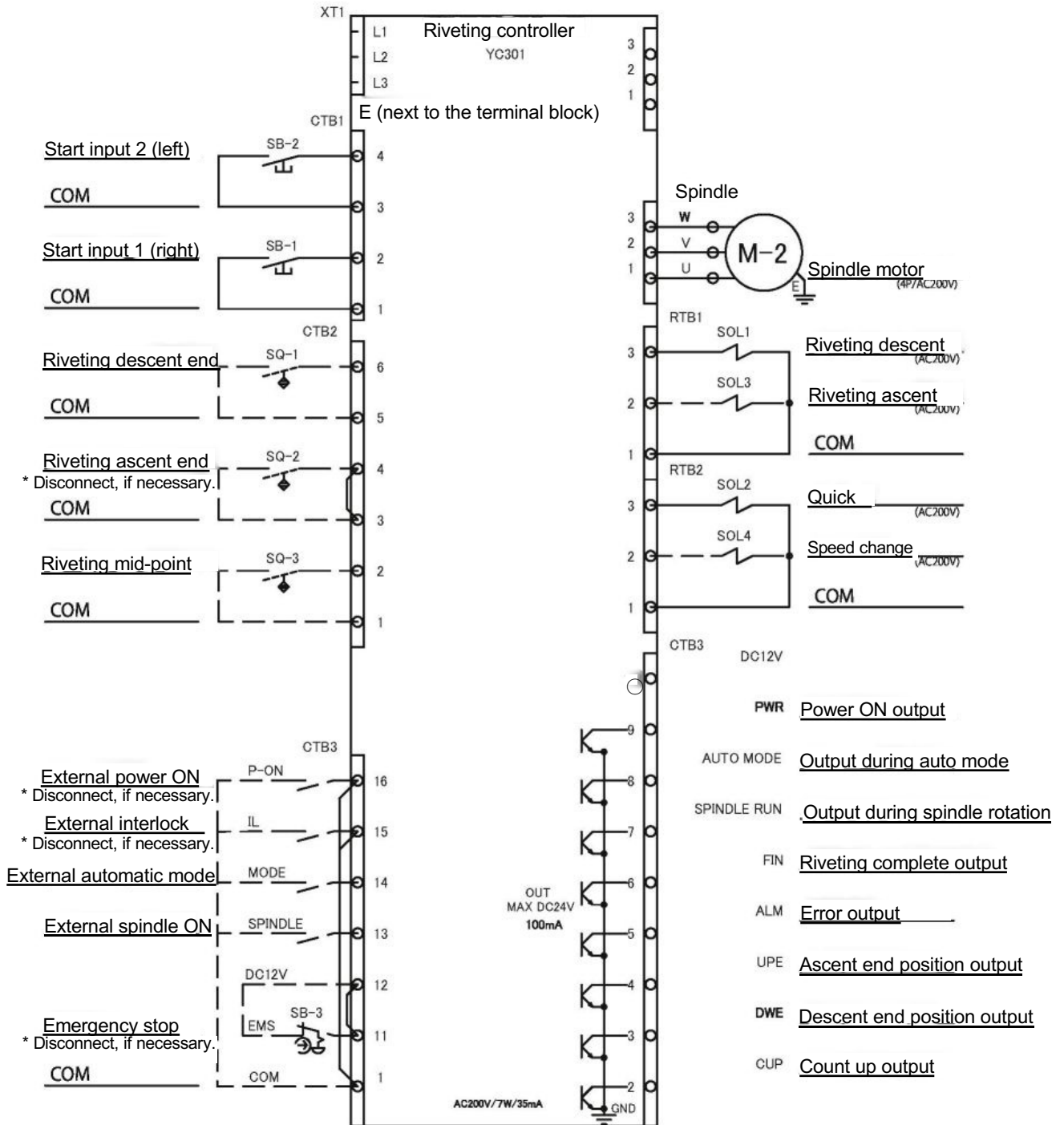

## 9. External signals

The YC-301 controller can exchange the following signals with external devices.

External signals which the YC301 can receive	Signals which YC-301 can send to other devices.
Emergency stop	When the power is ON
External power ON	In automatic mode
External interlock ON	Spindle is rotating
External automatic mode	Riveting completed
External spindle	Error
	Ascent end position
	Descent end position
	Count up output

When exchanging input/output signals with an external device, refer to the separate "Operation Manual (External Input/Output)".



---

■ Memo





## **YOSHIKAWA IRON WORKS CO., LTD.**

Headquarters & Workshop: 3-7, Shitomiya Honmachi, Shijonawate City, Osaka  
TEL: (072)876-5151 FAX: 072-878-3329

Tokyo Sales Office: 4-12, 4 Chome, Okudo, Katsushika Ward, Tokyo  
TEL: (03)3694-1631 FAX: 03-3696-6090

Nagoya Sales Office: 1806, 1 Chome, Takenoyama, Nisshin City, Aichi  
TEL: (0561)75-6660~5 FAX: 0561-74-2332