

Y O S H I K A W A

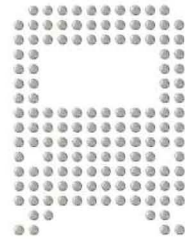

I R O N

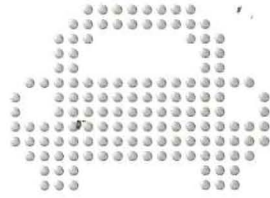
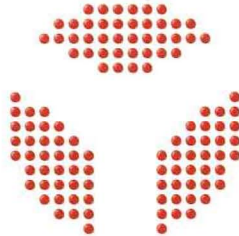

W O R K S

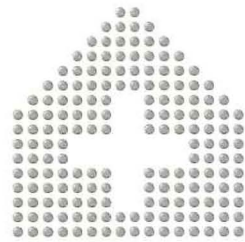

C O . , L T D .

P R O D U C T S C A T A L O G



Electrical Servo Riveting Machine

This new type of riveting machine is developed based on the demand of future. It drives by electricity only, no air pressure and oil pressure need to be built in. This is an eco-friendly machine, and suitable for riveting very tiny and precision parts.

Work management by the programmed input

Easy to set up stroke position, pressure, speed, spin speed, riveting time and other detail information on computer.

Shorten the preparation of setting.

All working procedures are registered and saved on the PC. Open the registered and saved setting will shorten setting time.

High Precision of repetition

It is hard to be affected by the temperature changes in factory, perform a highly precision and repetition work.

Suitable for riveting very tiny and precision parts.

The speed and pressure can be set and changed per 1 cycle, which is suitable for riveting very tiny and precision parts.

Shorten the work cycle time

The program can set to high-speed operation when not in riveting and dwell time, the time of working cycle can be shortened.

Environmental awareness

No driving sound of air exhauster or the hydraulic pump, it provides a lower noise working environment and improves the neighborhood relationship by lower noise. There is not waste oil treatment. The machine is an eco-design, which maintenance is simpler than Hydraulic and Pneumatic riveting machine and with low frequency of replacement parts.

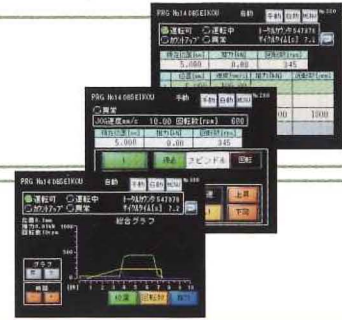

FRE-05

Riveting capacity (mild steel) : $\phi 0.5 \sim \phi 5\text{mm}$
Operating pressure : 5kN (510kgf)
Cylinder stroke : MAX 60mm
Operation time (sec) : 0 ~ 9.9sec
Spindle motor : 400w AC200V 50/60Hz
Motor : 750w AC200V 50/60Hz
Power supply : 3 ϕ AC200V 50/60Hz 3.5kVA
Floor space : W270xD450mm
Overall height : 1,063mm
Net weight : (The main body) 140kg
(Base, Controller) 60kg

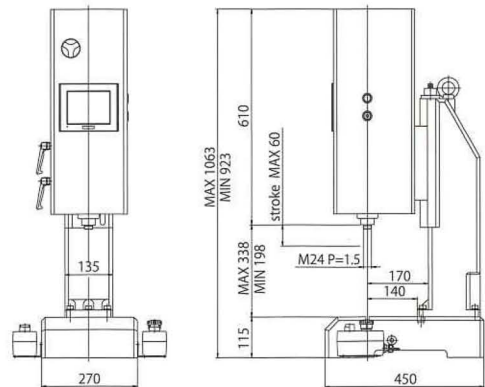

FRE-20

Riveting capacity (mild steel) : $\phi 4 \sim \phi 12\text{mm}$
Operating pressure : 20kN (2,040kgf)
Cylinder stroke : MAX 100mm
Operation time (sec) : 0 ~ 9.9sec
Spindle motor : 1.5kw AC200V 50/60Hz
Motor : 3.0kw AC200V 50/60Hz
Power supply : 3 ϕ AC200V 50/60Hz 17kVA
Floor space : W600xD1,040mm
Overall height : 2,037mm
Net weight : (The main body) 850kg
(Base, Controller) 250kg

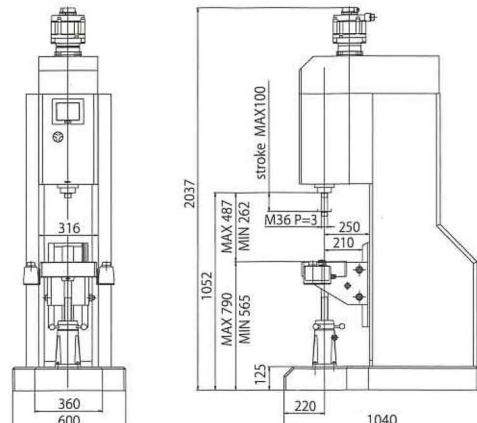



Hydraulic Riveting Machine

Hydraulic Riveting Machine is the most standard riveting machine which is rich in a variation kind from small size to super large size. Please choose the machine based on riveting ability and work condition from the abundant lineup.

US-36

Riveting capacity (mild steel) : $\phi 0.5 \sim \phi 6$ mm
 Operating pressure : 6.9kN(700kgf)
 Cylinder stroke : 0~35mm
 Operation time (sec) : 0.2 ~ 9.99sec
 Spindle motor : 200w AC200V 50/60Hz
 Pump motor : 400w AC200V 50/60Hz
 Power supply : 3 ϕ AC200V 50/60Hz 1.2kVA
 Floor space : W270xD450mm
 Overall height : 992mm
 Net weight : 150kg

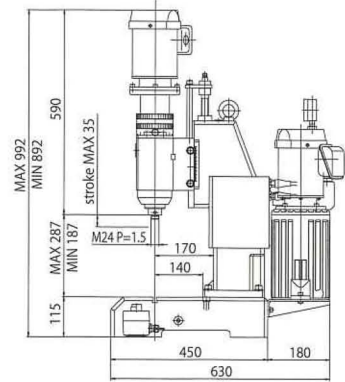
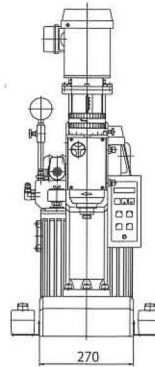

US-70

Riveting capacity (mild steel) : $\phi 3 \sim \phi 10$ mm
 Operating pressure : 14.8kN(1,500kgf)
 Cylinder stroke : 0~50mm
 Operation time (sec) : 0.2 ~ 9.99sec
 Spindle motor : 400w AC200V 50/60Hz
 Pump motor : 750w AC200V 50/60Hz
 Power supply : 3 ϕ AC200V 50/60Hz 2.1kVA
 Floor space : W417xD770mm
 Overall height : 1,637mm
 Net weight : 345kg

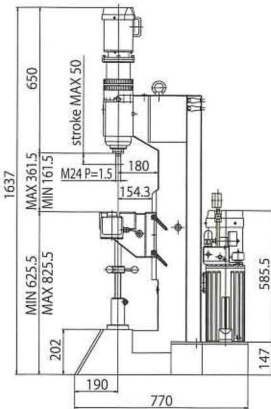
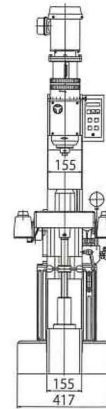

US-150

Riveting capacity (mild steel) : $\phi 6 \sim \phi 15$ mm
 Operating pressure : 24.5kN(2,500kgf)
 Cylinder stroke : 0~45mm
 Operation time (sec) : 0.2 ~ 9.99sec
 Spindle motor : 1.5kw AC200V 50/60Hz
 Pump motor : 1.5kw AC200V 50/60Hz
 Power supply : 3 ϕ AC200V 50/60Hz 4.9kVA
 Floor space : W612.5xD900mm
 Overall height : 1,813.5mm
 Net weight : 680kg

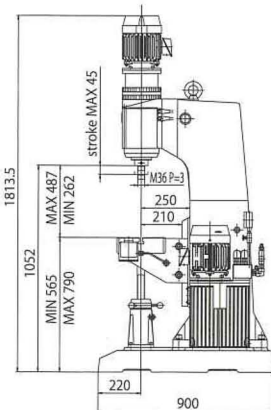
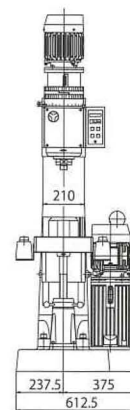

US-600

Riveting capacity (mild steel) : $\phi 20 \sim \phi 42$ mm
 Operating pressure : 196kN(20,000kgf)
 Cylinder stroke : 20~100mm
 Operation time (sec) : 0.2 ~ 9.99sec
 Spindle motor : 7.5kw AC200V 50/60Hz
 Pump motor : 5.5kw AC200V 50/60Hz
 Power supply : 3 ϕ AC200V 50/60Hz 27kVA
 Floor space : (The main body) W900xD1,580mm
 : (Hydraulic fluid reservoir) W630xD830mm
 Overall height : 3,295mm
 Net weight : (The main body) 5,600kg
 : (Hydraulic fluid reservoir) 700kg

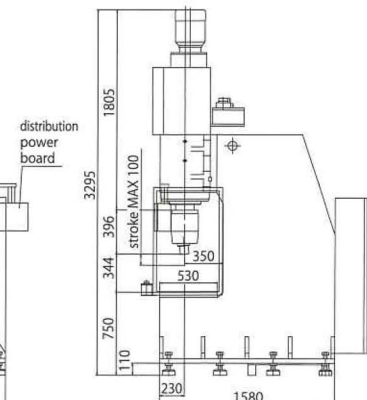
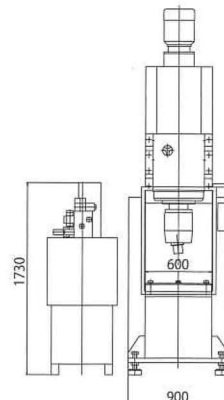
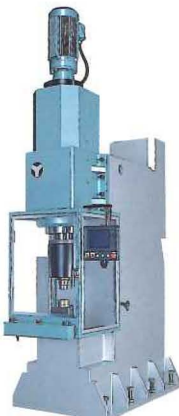



Pneumatic Riveting Machine

The main body of Pneumatic Riveting Machine is smaller than the general Hydraulic Riveting Machine and is suitable for small riveting process. It can be installed in narrow and limited space; the machine is superior in operability and maintenance.

US-1

Riveting capacity (mild steel) : $\phi 0.5 \sim \phi 3\text{mm}$
Operating pressure Max : 1.27kN (130kgf)
Cylinder stroke : 0~30mm
Operation time (sec) : 0.2 ~ 9.99sec
Spindle motor : 40w AC100V 50/60Hz
Air pressure : 0.49MPa (5kgf/cm²)
Power supply : 1 ϕ AC100V 50/60Hz 140VA
Floor space : W200xD330mm
Overall height : 675mm
Net weight : 37kg

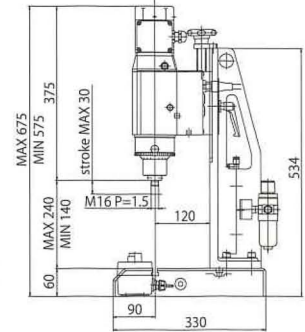
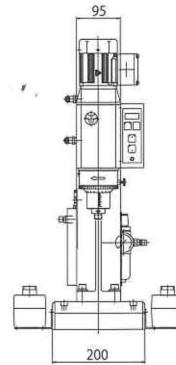

US-66

Riveting capacity (mild steel) : $\phi 0.5 \sim \phi 5\text{mm}$
Operating pressure Max : 5kN (515kgf)
Cylinder stroke : 5~40mm
Operation time (sec) : 0.2 ~ 9.99sec
Spindle motor : 120w AC200V 50/60Hz
Air pressure : 0.412MPa (4.2kgf/cm²)
Power supply : 3 ϕ AC200V 50/60Hz 280VA
Floor space : W270xD450mm
Overall height : 837mm
Net weight : 130kg

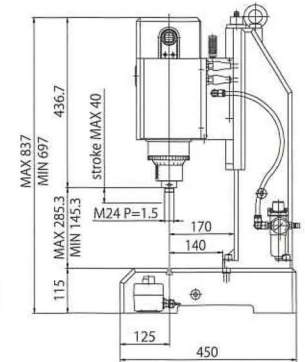
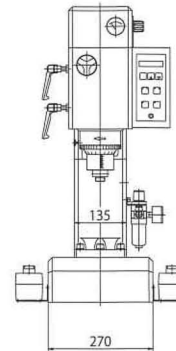

We will design and produce variety of rivet heads and inserts to fulfill your requirements.

Different shapes of insert heads for various types of riveting works.

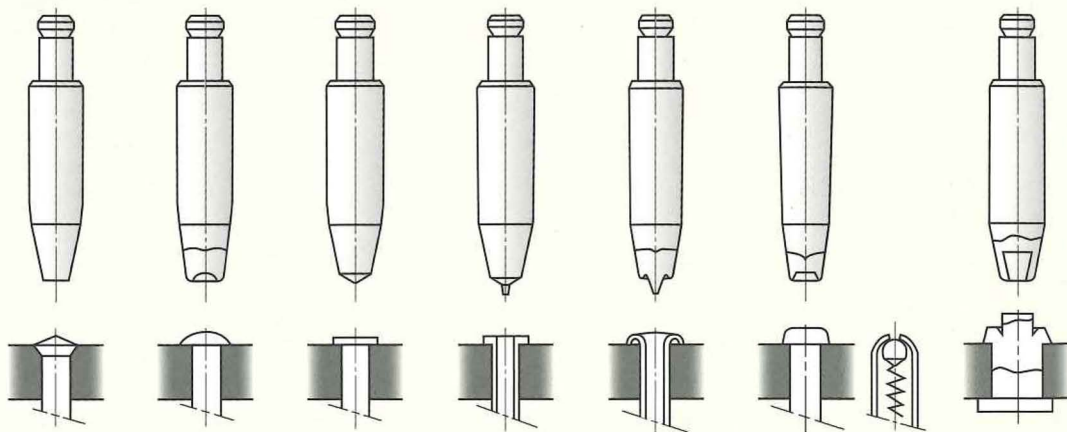

- Taper head (Standard)
- Button head (Standard)
- Flat head (Standard)
- Hollow flat head (option)
- Hollow bead head (option)
- Pen head (option)
- Recessed head (option)



The precise assembling of components is a prerequisite for creating advanced technology, which can help to enhance the quality of lives. Riveting is an indispensable element in this process.

YOSHIKAWA is one of the pioneers of riveting machines manufacturer. Our superior riveting systems with their advanced mechatronics, have been empowering manufactures to develop all kinds of innovative machines. Through our Rivetronics advanced riveting technology, we aim to contribute to a bright future where technology helps to turn people's dreams into reality.

YOSHIKAWA advanced riveting technology

■ C Type Riveting Accessory

The head and insert will be interfered in normal riveting with a \sqsupset shape component, C Type Riveting Accessory can works perfectly in this situation.

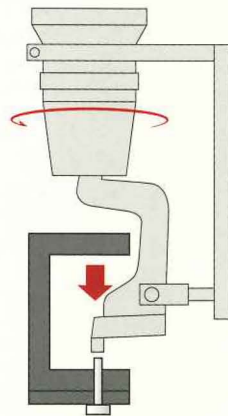

■ LC Type Riveting Accessory

In the case of the \sqsupset shape cannot work with the C type riveting accessory, LC Type Riveting Accessory is another solution for riveting. (Accessories interferes with each other)

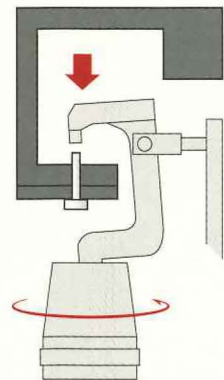

■ Roller Head Riveting Accessory

This Roller Head Riveting Accessory is used for "curling in" or "curling out" the pipe-formed works. A large scale of work is available by adding this accessory.

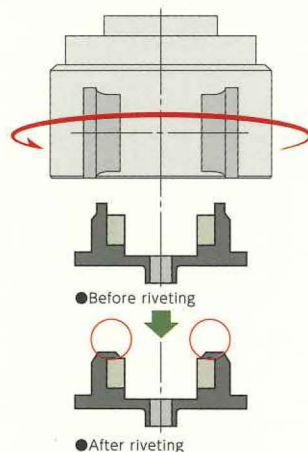

■ Multi Spindle Riveting Accessory

Multi Spindle Riveting Accessory allows riveting to be done on more than two rivets at a time.

※Some works cannot be riveted on the same time because of the rivet point distance.
 ※Multi Spindle Riveting Accessory can be used on multi point riveting machines only.

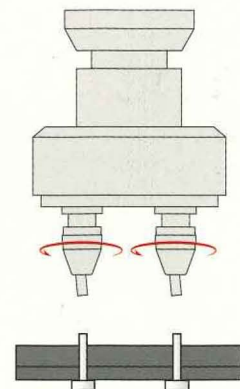

From an original riveting machine to a riveting system.

■ High flexibility to cope with today's increasingly diverse specifications.

A wide range of basic models and custom built system to fulfill the requirements of high quality products and efficiently production line.

■ Adaptable to all specialized operations

Our experienced team can assist you by providing solutions for your most demanding rivet setting needs, a full range of extra services included accessory devices and system supply.

■ E-Type Series freely mountable

The freely mountable E-Type Series is a single unit which can be included as part of a labor-saving automated system and it is available in the full range of our models.

■ Main specifications

Actuation system Model number Specifications	Servo control		Hydraulic						Pneumatic	
	FRE-05	FRE-20	US-36	US-70	US-150	US-180	US-300	US-600	US-1	US-66
Riveting capacity (mild steel mm φ)	0.5~5	4~12	0.5~5	3~10	6~15	9~21	15~30	20~42	0.5~3	0.5~5
Overall height (mm)	1,063	2,037	992	1,637	1,813.5	2,279	2,580	3,295	675	837
Gap (mm)	140(170)	210	140(170)	154	210	205	185	350	120	140(170)
Table space (width x length /mm)	250x230	294x244	250x230	260x156	294x244	394x294	396x296	400x400	190x185	250x230
Floor space (width x length /mm)	270x450	600x1,040	270x450	417x770	612.5x900	805x1,270	1,080x1,580	The main body 900x1,450 Hydraulic fluid reservoir 630x830	200x330	270x450
Stroke (min.~max./ mm)	MAX.60	MAX.100	0~35	0~50	0~45	0~60	0~60	20~100	0~30	5~40
Distance between spindle & table (min.-max./ mm)	198 338	262 487	187 287	161.5 361.5	262 487	309 549	408 558	710 (Fixation)	140 240	145 285
Operating pressure (max.kN) (max.kgf)	5.0 510	20 2,040	6.9 700	14.8 1,500	24.5 2,500	39.2 4,000	98.0 10,000	196.0 20,000	1.27 130	5.0 515
Spindle motor	3φ200V 400W (Inverter control) OP.Servo control	3φ200V 1.5kW (Inverter control) OP.Servo control	3φ200V 200W	3φ200V 400W	3φ200V 1.5kW	3φ200V 2.2kW	3φ200V 11kW (Inverter control)	3φ200V 7.5kW Include Speed reducer 1/3 (Inverter control)	1φ100V 40W	3φ200V 120W
Pump motor	—	—	3φ200V 400W	3φ200V 750W	3φ200V 1.5kW	3φ200V 2.2kW	3φ200V 5.5kW	3φ200V 5.5kW	—	—
Servo motor	3φ200V 750W	3φ200V 3.0kW	—	—	—	—	—	—	—	—
Net weight (kg)	The main body 140 Base,Controller 60	The main body 850 Base,Controller 250	150	345	690	1,400	3,800	The main body 5,600 Hydraulic fluid reservoir 700	37	130

※Specifications subject to change without notice.



Half a century with riveting

YOSHIKAWA IRON WORKS CO., LTD.

URL : <http://www.riveting-mcn.co.jp> E-mail : sale@riveting-mcn.co.jp

■ HEAD OFFICE

3-7, Shinmachi, Shitomiya, Shijyonawate, Osaka, 575-0041, Japan
Phone : +81-72-876-5151 Fax : +81-72-878-3329

■ TOKYO OFFICE

4-12, 4-chome, Okudo, Katsushika-ku, Tokyo, 124-0022, Japan
Phone : +81-3-3694-1631 Fax : +81-3-3696-6090

■ NAGOYA OFFICE

1806, Takenoyama 1-chome, Nisshin City, Aichi, 470-0136, Japan
Phone : +81-561-75-6660 Fax : +81-561-74-2332

■ FUKUOKA OFFICE

12-1-1, 3-chome, Kiyokawa, Chuo-ku, Fukuoka, 810-0005, Japan
Phone : +81-92-522-6964 Fax : +81-92-522-6620